

# SUBMITTAL DATA SHEET

Series Name: Electric Heater  
Model Number: EAH-08C(UL)



## Heater

Location: \_\_\_\_\_  
 Engineer: \_\_\_\_\_  
 Submitted to: \_\_\_\_\_  
 Submitted by: \_\_\_\_\_  
 Reference: \_\_\_\_\_

Approval: \_\_\_\_\_  
 Date: \_\_\_\_\_  
 Construction: \_\_\_\_\_  
 Unit #: \_\_\_\_\_  
 Drawing #: \_\_\_\_\_

## SPECS

<b>Code</b>	22013200000062	
<b>Model</b>	EAH-08C(UL)	
<b>Normal Operational Voltage</b>	(V, Ph, Hz)	208 / 230, 1, 60
<b>Current</b>	A	28.8 / 32
<b>Heat Power</b>	kW	6 / 7.35
<b>MCA</b>	A	37 / 42
<b>MAX. FUSE</b>	A	40 / 45
<b>Heater dimension</b>	mm	497 x 230 x 112
	inch	19.57 x 9.06 x 4.41
<b>Packaging dimension</b>	mm	585 x 335 x 160
	inch	23 x 13.19 x 6.3
<b>Net Weight</b>	kg	2
	lbs	4
<b>Gross Weight</b>	kg	4
	lbs	9



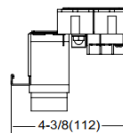
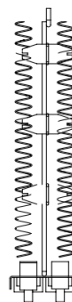
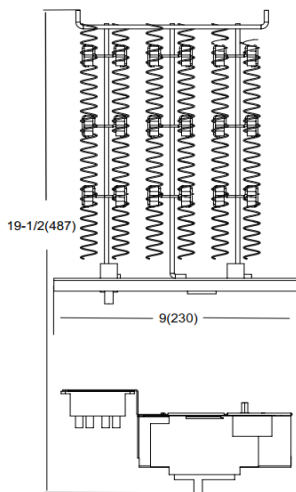
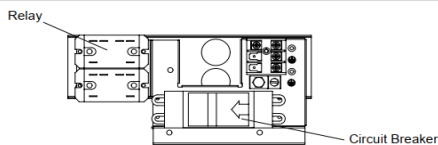

## Heater dimension

unit: inch (mm)



### 8KW/10KW HEAT KIT

-  : THERMAL CUT-OUT(Cut-off temperature 98°C, holding temperature 83°C, limiting temperature 410°C.)
-  : THERMAL LINK, SELF-RESETTING(Break-off temperature 60 ± 3°C, reset temperature 43 ± 6°C.)

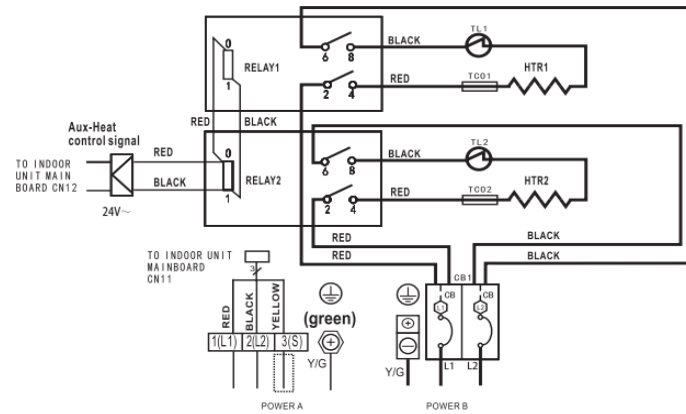

**NOTE1:**  This symbol indicates the element is optional. The wiring type of the actual unit shall prevail.

**NOTE2:** Please attach the nameplate to the cover of the electric control box. All the round holes located on the plate represent numbers. Please refer to the Installation Manual for details.

Round hole number	Relay number	Round hole number	Circuit breaker number
○	RELAY 1	○	CB1
○	RELAY 2		
○			
○			

**NOTE3:** TO BE WIRED IN ACCORDANCE WITH NEC AND LOCAL CODES.

**NOTE4:** POWER A,B,C,D ARE DIFFERENT POWERS.

The wiring mode of power supply A shall be based on the type of original wiring terminal of AHU; for type A, S position must be connected to the outdoor S; for type B, S position shall not be connected.



## **North American HVAC Products Ltd.**

---

Add.: #100 5118 N Fraser Wy, Burnaby, BC V5J 0H1

Tel: 604-430-8496 [info@nahvac.com](mailto:info@nahvac.com) [www.nahvac.com](http://www.nahvac.com)

Midea reserves the right to change the specifications of the product, and to withdraw or replace products without prior notification or public announcement.  
Midea is constantly developing and improving its products.