

**WIRED REMOTE CONTROLLER**

# **Installation and Owner ' s Manual**

**MODEL: KJR-120N(X6W)/BGEF**



**IMPORTANT NOTE:**

Please read this manual carefully before installing or operating your wired remote controller. Make sure to save this manual for future reference.



This manual gives detailed description of the precautions that should be brought to your attention during operation.

In order to ensure correct service of the wired controller please read this manual carefully before using the unit. For convenience of future reference, keep this manual after reading it.

All the pictures in this manual are for explanation purpose only. There may be slightly different from the wired remote controller you purchased (depend on model). The actual shape shall prevail.

# Table of Contents

1. Safety precaution .....	01
2. Installation accessory .....	07
3. Installation method .....	09
4. Specification .....	17
5. Feature and function of the wired controller .....	18
6. Name on the LCD of the wired controller .....	19
7. Name of button on the wired controller .....	20
8. Preparatory operation .....	21
9. Operation .....	23
10. Timer functions .....	33
11. Weekly Timer 1 .....	36
12. Weekly Timer 2 .....	42
13. Fault alarm handing .....	49
14. Technical indication and requirement .....	49
15. Queries and settings .....	50
16. Wireless control connection .....	55

## 1. Safety precaution

### **WARNING**

- Please entrust the distributor or professionals to install the unit.
- Installation by other persons may lead to imperfect installation, electric shock or fire.
- Adhere to this installation manual.
- Improper installation may lead to electric shock or fire.
- Reinstallation must be performed by professionals.

Do not uninstall the unit randomly.

Random uninstalling may lead to abnormal operation, heating or fire of the air condition.

### **NOTE**

- Do not install the unit in a place vulnerable to leakage of flammable gases. Once flammable gases are leaked and left around the wire controller, fire may occur.

## 1. Safety precaution

- Do not operate with wet hands or let water enter the wire controller. Otherwise, electric shock may occur. The wiring should adapt to the wire controller current. Otherwise, electric leakage or heating may occur and result in fire.
- The specified cables shall be applied in the wiring. No external force may be applied to the terminal. Otherwise, wire cut and heating may occur and result in fire.
- The specified cables shall be applied in the wiring. No external force may be applied to the terminal. Otherwise, wire cut and heating may occur and result in fire.

## 1. Safety precaution



### BATTERY WARNING



**WARNING:** Contains coin battery.



### **WARNING**

**INGESTION HAZARD:** This product contains a button cell or coin battery.



### **BATTERY WARNING: KEEP OUT OF REACH OF CHILDREN;**

- If the battery compartment (if applicable) does not close securely, stop using the product and keep it away from children;
- If you think batteries might have been swallowed or placed inside any part of the body, seek immediate medical attention.

## 1. Safety precaution



### BATTERY WARNING

#### KEEP OUT OF REACH OF CHILDREN.

Swallowing can lead to chemical burns, perforation of soft tissue, and death. Severe burns can occur within 2 hours of ingestion. Seek medical attention immediately.



### WARNING

- **INGESTION HAZARD:** This product contains a button cell or coin battery.
- **DEATH** or serious injury can occur if ingested.
- A swallowed button cell or coin battery can cause **Internal Chemical Burns** in as little as **2 hours**.
- **KEEP** new and used batteries **OUT OF REACH** of **CHILDREN**.
- **Seek immediate medical attention if a battery** is suspected to be swallowed or inserted inside any part of the body.



## 1. Safety precaution

### **WARNING**

- Remove and immediately recycle or dispose of used batteries according to local regulations and keep away from children. Do NOT dispose of batteries in household trash or incinerate.
- Even used batteries may cause severe injury or death.
- Call a local poison control center for treatment information.
- Non-rechargeable batteries are not to be recharged.
- Do not force discharge, recharge, disassemble, heat above (-20-70°C) or incinerate. Doing so may result in injury due to venting, leakage or explosion resulting in chemical burns.
- Ensure the batteries are installed correctly according to polarity (+ and -).
- Do not mix old and new batteries, different brands or types of batteries, such as alkaline, carbon-zinc, or rechargeable batteries.

## 1. Safety precaution

### **WARNING**

- Remove and immediately recycle or dispose of batteries from equipment not used for an extended period of time according to local regulations.
- Always completely secure the battery compartment. If the battery compartment does not close securely, stop using the product, remove the batteries, and keep them away from children.
- Battery type: CR2032
- Battery nominal voltage: 3.0 V

## 2. Installation accessory

### Select the installation location

Don't install at the place where cover with heavy oil, vapor or sulfureted gas, otherwise, this product would be deformed that would lead to system malfunction.

### Preparation before installation

1. Please confirm that all the following parts you have been supply.

No.	Name	Qty.	Remarks
1	Wire controller	1	_____
2	Installation and owner's manual	1	_____
3	Screws	3	M3.9*25 (For Mounting on the Wall)
4	Wall plugs	3	For Mounting on the Wall
5	Screws	2	M4X25 (For Mounting on switch box)
6	Plastic screw bars	2	For fixing on switch box
7	Battery	1	
8	The connective wires group	1	Optional
9	Screw	1	M4X8(For Mounting the connective wire group)

## 2. Installation accessory

### 2. Prepare the following assemblies on the site.

No.	Name	Qty.(embedded into wall)	Specification (only for reference)	Remarks
1	Switch box	1	_____	_____
2	Wiring Tube(Insulating Sleeve and Tightening Screw)	1	_____	_____

#### Precaution of installing the wire controller

1. This manual provides the installation method of wired controller. Please refer to the wiring diagram of this installation manual to connect the wire controller with indoor unit.
2. The wired controller works in low voltage loop circuit. Forbid to directly contact the cable of high voltage above, like 115V,220V,380V, and don't wire this kind of wire in the said loop; wiring clearance between configured tubes should be at the range of 300~500mm or above.
3. The shielded wire of the wired controller must be grounded firmly.
4. Upon finish the wire controller connection, do not employ tram egger to detect the insulation.

### 3. Installation method

#### 1.Wired remote controller structural dimensions

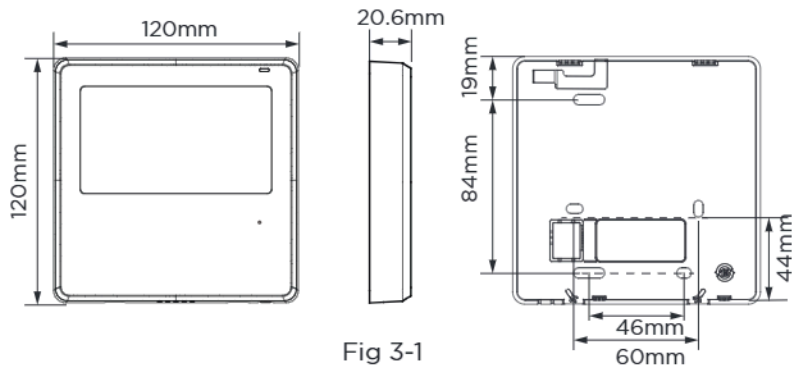

#### 2.Remove the upper part of wired controller

- Insert a slot screwdriver into the slots in the lower part of the wired controller (2 places), and remove the upper part of the wire controller. (Fig.3-2)

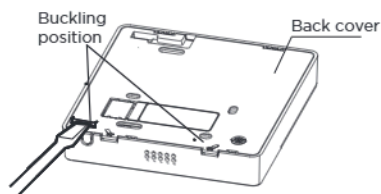

**NOTE:** Do not pry up and down, you can only rotate the screwdriver.

### 3. Installation method

**NOTE:** The PCB is mounted in the upper part of the wired controller. Be careful not to damage the board with the slot screwdriver.

#### 3. Fasten the back plate of the wired controller

- For exposed mounting, fasten the back plate on the wall with the 3 screws (ST3.9\*25) and plugs. (Fig.3-3)

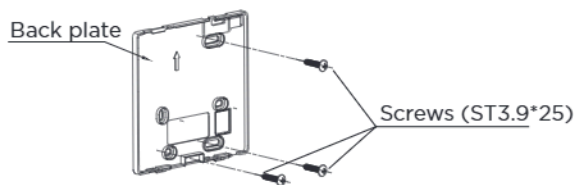

Fig 3-3

- Use two M4X25 screws to install the back cover on the 86 switch box, and use one ST3.9\*25 screw to fix to the wall.

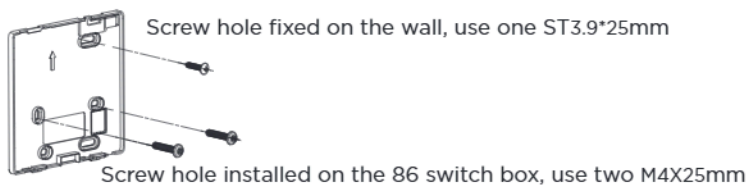

Fig 3-4

### 3. Installation method

**NOTE:** Put on a flat surface. Be careful not to distort the back plate of the wire controller by overtightening the mounting screws.

### 4. Battery installation

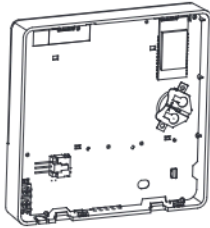
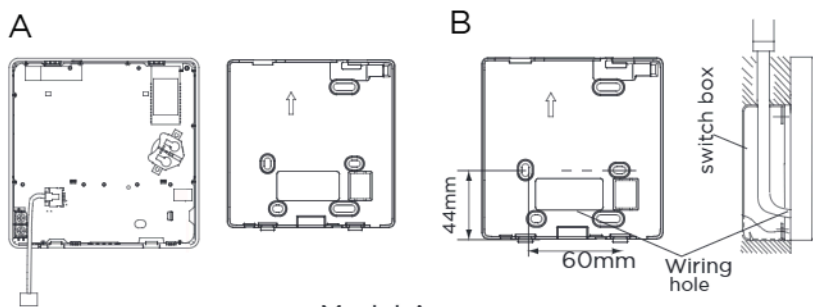

Fig 3-5

- Please contact professional technical after-sales service if the battery needs to be replaced.
- Put the battery into the installation site and make sure the positive side of the battery is in accordance with the positive side of installation site.(See Fig.3-5)
- Please set the time corrected on the first-time operation. Batteries in the wire controller can time under power failure which ensure the time keep right. When the power restores, if the time displayed is not correct, it means the battery is dead and replace the battery.

### 3. Installation method

#### 5. Wire with the indoor unit



Model A

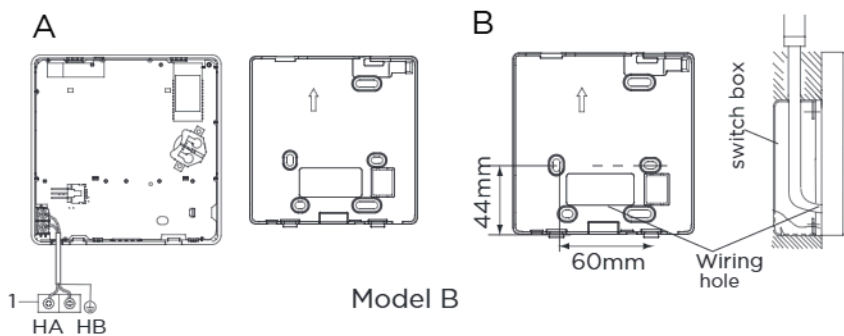

Model B

Fig 3-6

### 3. Installation method

#### Model A

Connect the wire from the display panel of the indoor unit to a connecting cable. Then connect the other side of the connecting cable to the remote control.

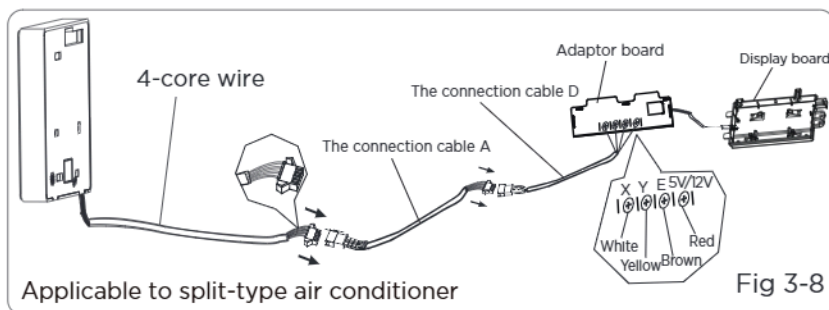
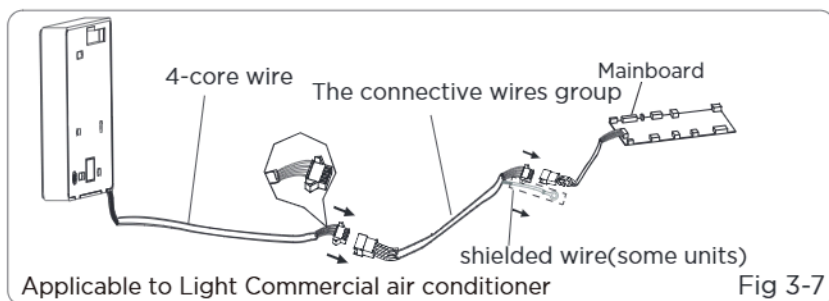

### 3. Installation method

#### Model B

1 indoor unit

Notch the part for the wiring to pass through with nippers, etc. Connect the terminals on the wired controller (HA ,HB), and the terminals of the indoor unit (HA ,HB). (HA and HB do not have polarity.)

#### NOTE

- DO NOT allow water to enter the wired control. Use the trap and putty to seal the wires.
- Connecting wires must be fixed reliably and cannot be pulled.

For some units, the wired controller connects to the unit HA and HB ports through the HA and HB ports. There is no polarity between HA and HB. See Fig. 3-9.

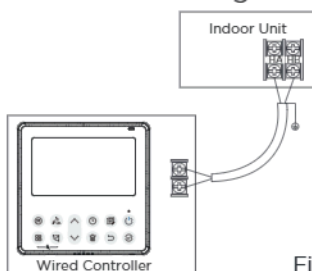
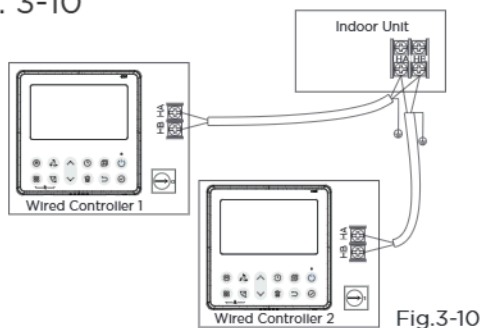

Fig.3-9

### 3. Installation method

The main/secondary wired controller can be used to enable two wired controllers to control one unit, and the wired controllers connect to the unit HA and HB ports through the HA and HB port on the controller. There is no polarity between HA and HB. See Fig. 3-10



#### NOTE

Wire controller with Wireless function does not have this function.

For some units, one wired controller can support multiple units (a maximum of 16 units). In this case, the wired controller and unit need to be connected

### 3. Installation method

to the HA and HB ports at the same time. In group control, there will be no error displayed on the wired controller . See Fig. 3-11.

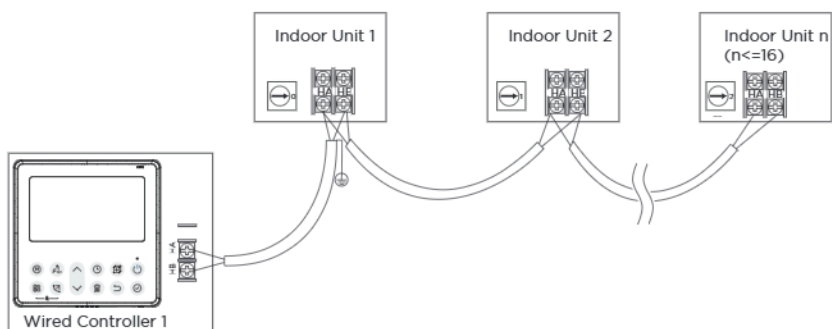

Fig.3-11

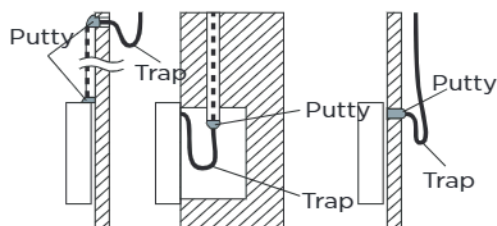
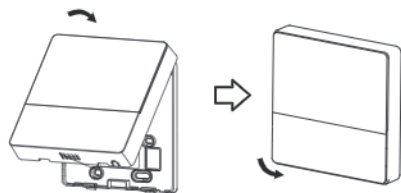

Fig 3-12

### 3. Installation method

#### 6. Reattach the upper part of the wired controller

- After adjusting the upper case and then buckle the upper case; avoid clamping the wiring during installation. (Fig 3-13)



All the pictures in this manual are for explanation purpose only. Your wire controller may be slightly different. The actual shape shall prevail.

Fig 3-13

### 4. Specification

Input voltage	12V
Ambient temperature	0-43°C(32-110°F)
Ambient humidity	RH40%-RH90%

#### Wiring specifications

**NOTE:** Suggested to use the connective wire of 6 meters length.

## 5. Feature and function of the wired controller



### Feature:

- LCD display.
- Malfunction code display: it can display the error code, helpful for service.
- 4-way wire layout design, no raised part at backside, more convenient to place the wires and install the device.
- Room temperature display.
- Weekly Timer.

---

### Function:

- Mode: Choose Auto-Cool-Dry-Heat-Fan
- Fan speed: Auto/Low/Med/High speed
- Swing(on some models)
- Timer ON/OFF
- Temp setting
- Weekly timer
- Follow me
- Turbo
- 24-hour System
- 12-hour System
- Auto-restart
- Individual louver control (on some models)
- Automatic airflow test
- Rotation & Back-up
- Dual Control
- Group Control
- Child Lock
- LCD display
- Clock

## 6. Name on the LCD of the wired controller

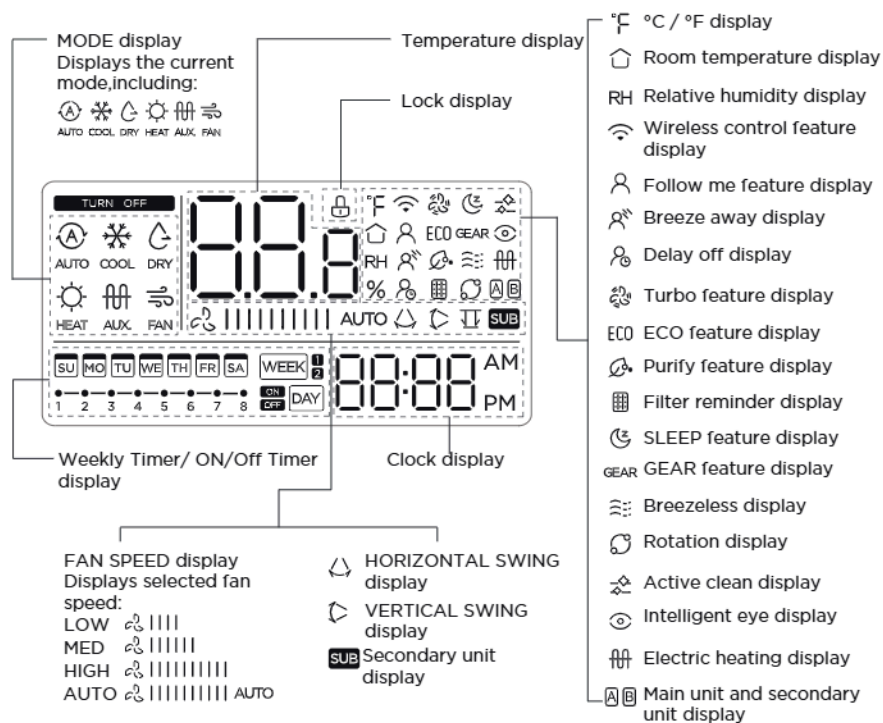

## 7. Name of button on the wired controller

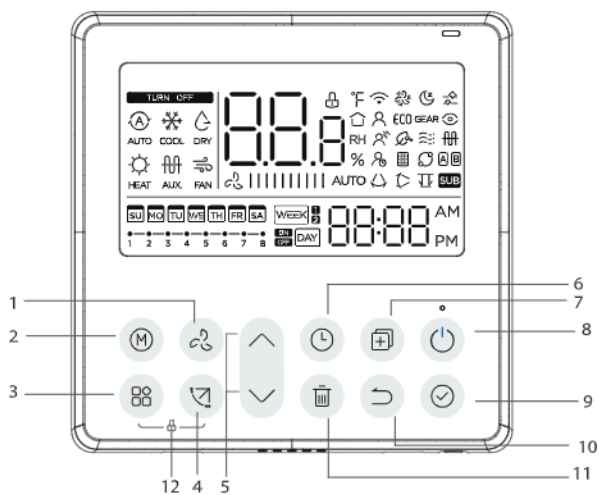

1. FAN SPEED button

2. MODE button

3. FUNC. button

4. SWING button

5. ADJUST button

6. TIMER button

7. COPY button

8. POWER button

9. CONFIRM button

10. BACK button

11. DAY OFF/DELAY button



12. CHILD LOCK button

## 8. Preparatory operation

### Set the current day and time

-  Press the Timer button for 2 seconds or more.  
The timer display will flash.



---

-   
 Press the button “ ^ ” or “ ∨ ” to set the date.  
The selected date will flash.  



---

-  The date setting is finished and the time setting is prepared after pressing Timer button or CONFIRM button or there is no pressing button in 10 seconds.

---

-   
 Press the button “ ^ ” or “ ∨ ” to set the current time.  
Press repeatedly to adjust the current time in 1-minute increments. Press and hold to adjust the current time continuous.  
  
ex. Monday 11:20

---



-  The setting is done after pressing CONFIRM button or there is no pressing button in 10 seconds.

## 8. Preparatory operation

6



Time scale selection

Press the buttons “” and “” for 2 seconds will alternate the clock time display between the 12h & 24h scale.

## 9. Operation

### To start/stop operation



Press the Power button.

### 8 degree heating function



When the heating mode temperature is 16°C (60°F) or the set minimum temperature, press the key twice within 1 second to turn on the 8°C heating function. When the 8°C heating function is enabled, Follow me, SLEEP, Turbo and Daily Timer features are cancelled.

## 9. Operation

### To set the operation mode

Operation mode setting(Heat mode is invalid for cool only type unit)



Press this button to select the operation mode:



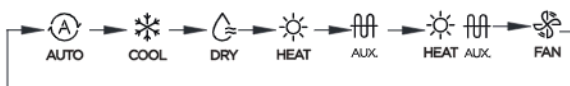

If the indoor unit has Aux. (Emergent heating) mode and Heat + Aux. mode, press the button to select the operation mode:

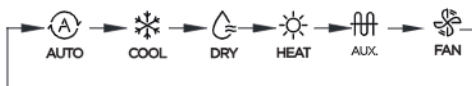

If the indoor unit has Aux. (Emergent heating) mode, but no Heat + Aux. mode, press the button to select the operation mode:





## 9. Operation

- When the mode is selected as emergency heating (or Aux) mode,  is displayed, the default fan speed is Auto, but you can adjust the fan speed. The Sleep, 8-degree heating, Turbo, and Rotation functions are not available in emergency heating mode.
- When the mode is selected as heating & Aux. mode,  is displayed, you can adjust the fan speed. The Turbo and Rotation functions are disable.

## 9. Operation

### Room temperature setting

-  Lower Press the button “ ^ ” or “ ∨ ” to set the room temperature. Indoor setting temperature range : 10/16/17~30°C(50/60/62-86°F ) or 20~28°C(68-82°F ). (Model dependent)
-  Raise

°C & °F scale selection (on some models)



Press the buttons “ ^ ” and “ ∨ ” for 3 seconds will alternate the temperature display between the °C & °F scale.

### Fan speed setting



Press the Fan speed button to set the fan speed. (This button is unavailable under Auto or Dry mode)



When stepless speed regulation is supported, press the fan speed key to cycle through:





Press the buttons (M) and  together for 3 seconds to turn on or turn off the keypad tone.

## 9. Operation

### Child lock function



Press the buttons “” and “” for 3 seconds to activate the child lock function and lock all buttons on the wire controller.

You can't press the button to operate and receive the remote-control signal after the child lock is activate.

Press these two buttons again for 3 seconds to deactivate the child lock function.

When the child lock function is activated, the “” mark appears.

### Swing function(For the units with horizontal & vertical swing features only)

#### 1 Up-Down swing



Press the SWING button to start up-down swing function. The “” mark appears. Press it again to stop.

#### 2 Left-Right swing

Press the Swing button for 2 seconds to start Left-Right swing function. The “” mark appears. Press it for 2 seconds again to stop.

## 9. Operation

### Swing function(For the units without vertical swing function )





- Use Swing button to adjust the Up-down airflow direction and start the auto swing function.

- 1.Each time you press this button, the louver swings an angle of 6 degrees. Press this button until the desired direction reaches.
  - 2.If press and hold the button for 2 seconds, the auto swing is activated. The “” mark appears. Press it again to stop. (some units)
- For the units with four Up-Down louvers, it can be operated individually.



- 1.Press the Swing button to activate the Up-Down adjusting louver function.

The  mark will flash.(Not applicable to all the models)

- 2.Pressing the button “” or “” can select the movement of four louvers. Each time you push the button, the louver will be selected in a sequence as:

(  means the four louvers move at the same time.)

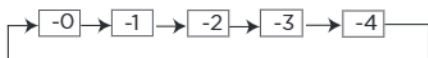



## 9. Operation

NOTE: The electric auxiliary heating function of the AHU model is switched by the MODE button , and the FUNC. button is a turbo function.

### Follow me function indicator

Press the FUNC. button to select whether the room temperature is detected at the indoor unit or the wire controller.

Intelligent eye display 

- 1.This function is valid in any mode of power-on state.
- 2.When the indoor unit sending wire controller has the smart eye function, press the function key to select the smart eye icon, press the OK key to turn on the smart eye, and light up the smart eye icon at the same time; when the smart eye is turned off, the smart eye icon goes out.
- 3.Shutdown, switch mode, turn on self-cleaning, turn on 8-degree heating function will automatically cancel the smart eye function.

Filter reset function 

After the indoor unit sends the wire controller filter usage time, the filter cleaning prompt icon lights up, press the function key to select the filter cleaning prompt icon, and press the OK key to reset the filter screen time. The filter cleaning reminder icon goes out.

## 9. Operation

### Humidity setting function

1. When the indoor unit sending wire controller has dual control function of temperature and humidity, in dehumidification mode, press the function key to select the RH icon, press the confirm key to enter the humidity control mode, the RH icon flashes, press the up and down keys to adjust the humidity, the setting range is OFF->35%-85%, adjusted with 5% humidity. Exit humidity adjustment state after 5 seconds of inactivity.

2. After entering the humidity control mode, press the up and down keys to adjust the set temperature and display the set temperature for 5 seconds, and then restore the set humidity display.

3. After switching the mode, exit the humidity control mode.

### GEAR function

1. When the indoor unit sending wire controller has the GEAR function, in the boot cooling mode, press the function key to select the GEAR icon, press the confirm key to enter the GEAR control mode, and first display the current GEAR status.

50%->75%->OFF can be switched by the up and down keys within 5 seconds. After 5 seconds, the set temperature will be displayed, press the up and down keys to adjust the set temperature.

## 9. Operation

Turn off, switch to mode or turn on sleep, ECO, strong, self-cleaning functions to cancel the GEAR function.

When the follow me function  indicator appears, the room temperature is detected by the wire controller.

Press the button again to cancel the follow me function.

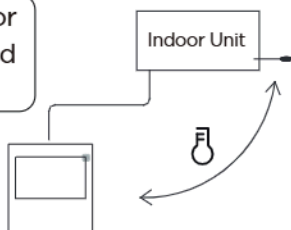

### Rotation & Back-up indication

When there are two units, press the button to select the rotating function, and press “Confirm” to turn on or off the rotating function.

1. Press “Confirm” to set the rotating time, then press the button “ $\wedge$ ” or “ $\vee$ ” to set time. Setting time range: 1-99h, the default time is 10 hours.

## 9. Operation

2. Step 2 set high temperature co-open temperature -- or 26-32 degrees -- that is, this function is invalid. When the ambient temperature is 26-32 degrees, when the ambient temperature is greater than or equal to the set temperature, the two machines will run 24 degrees at the same time in the COOL mode.
3. Step 3 set the low-temperature co-open temperature -- or 5-15 degrees -- that is, this function is invalid. When the ambient temperature is 5-15 degrees, when the ambient temperature is lower than the set temperature, the two units will run at the same time for 24 degrees to make the heating mode.
4. Step 4: set which machine will run first. Select A or B.
5. After this function is turned on, as long as the air conditioner is running at the setting hour, it will automatically turn on another air conditioner and turn off the current air conditioner. Press the POWER button to switch to another one immediately. A or B icons flicker to indicate the corresponding air conditioning failure. Automatically switch to another machine when running time is reached or machine failure occurs.

## 10. Timer functions

**WEEK**

WEEKLY timer

Use this timer function to set operating times for each day of the week.

**ON**

**DAY**

On timer

Use this timer function to start air conditioner operation.

The timer operates and air conditioner operation starts after the time has passed.

**OFF**

**DAY**

Off timer

Use this timer function to stop air conditioner operation.

The timer operates and air conditioner operation stops after the time has passed.

**ON**  
**OFF**

**DAY**

On and Off timer



Use this timer function to start and stop air conditioner operation. The timer operates and air conditioner operation starts and stops after the time has passed.

## 10. Timer functions

### To set the On or Off TIMER

- 1  Press the Timer button to select the **ON DAY** or **OFF DAY** .
-  A horizontal flow diagram showing the sequence of button presses: WEEK (with a small '1' in a box) → WEEK (with a small '2' in a box) → ON DAY → OFF DAY → ON DAY → OFF DAY → No display. A large right-facing curly bracket is positioned below the entire sequence.



- 2  Press the Confirm button and the Timer display is flashing.

- 3   Press the button “ ^ ” or “ ∨ ” to set the time.  
After the time is set, the timer will start or stop automatically.
-  A digital display showing '18:00' with a flashing colon. To the left of the display is a small 'OFF' icon and a 'DAY' icon in a box. Below the display is the text 'ex. Off timer set at 18:00'.

- 4  Press the Confirm button again to finish the settings.

## 10. Timer functions



### To set the On and Off TIMER

-  Press the Timer button to select the  .

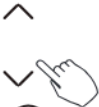

---

-  Press the Confirm button and the Clock display is flashing.

---

-   
  
 Press the button “ ^ ” or “ ∨ ” to set the time of On timer, and then press the Confirm button to confirm the setting.

---

-   
 Press the button “ ^ ” or “ ∨ ” to set the time of Off timer.

---

-  Press the Confirm button to finish the settings.

**NOTE:** The secondary wired controller cannot set the timer.

# 11. Weekly Timer 1

## 1 Weekly timer setting



Press the Timer button to select the **WEEK** and then press the Confirm button to confirm.



## 2 Day of the week setting



Press the button “ ^ ” or “ √ ” to select the day of the week and then press the Confirm button to confirm the setting.



## 3 ON timer setting of timer setting 1



Press the button “ ^ ” or “ √ ” to set the time of On timer and then press the Confirm button to confirm the setting.



## 11. Weekly Timer 1



ex. Tuesday time scale 1

Up to 4 timer settings can be saved for each day of the week. It is convenient if the WEEKLY TIMER is set according to the user's life style.

### 4 Off timer setting of timer setting 1



Press the button “^” or “v” to set the time of Off timer and then press the Confirm button to confirm the setting.



ex. Tuesday time scale 1

5 Different timer settings can be set by repeating step 3 to 4.

6 Other days in one week can be set by repeating step 2 to 5.

**NOTE:** The weekly timer setting can be returned to the previous step by pressing Back button. The time of timer setting can be deleted by pressing Day off button. The current setting will be restored and withdrawn the weekly timer setting automatically when there is no operation for 30 seconds.

## 11. Weekly Timer 1

### WEEKLY timer operation

To activate WEEKLY TIMER operation



Press the Timer button while **WEEK** is displayed on the LCD.



To deactivate WEEKLY TIMER operation



Press the Timer button while **WEEK** disappears from the LCD.

### To turn off the air conditioner during the weekly timer



1. If press the Power button once and quickly, the air conditioner will turn off temporarily. And the air conditioner will turn on automatically until the time of On timer.



ex. If press the POWER button once and quickly at 10:00, the air conditioner will turn on at 14:00.

2. When press the Power button for 2 seconds, the air conditioner will turn off completely, at the same time cancel the timing function.

## 11. Weekly Timer 1

### To set the DAY OFF (for a holiday)

1  During the weekly timer, press the Confirm button.

---

2   
 Press the button “^” or “v” to select the day in this week.

---

3  Press the Day off button to set the DAY OFF.



ex. The DAY OFF is set for Wednesday

---

4 The DAY OFF can be set for other days by repeating the steps 2 and 3.

---

5  Press the Back button to back to the weekly timer.

---

To cancel: Follow the same procedures as those for setup.

#### NOTE

The DAY OFF setting is cancelled automatically after the set day has passed.

## 11. Weekly Timer 1

### DELAY function



During the weekly timer, press the FUNC. button, select the delay function and press the Confirm button, display "0h" "1h" "2h" and wait 3 seconds to confirm. When the delay function is activated, the "⌚" mark appears.



The delay function can only be enabled in Weekly Timer 1 and Weekly Timer 2.

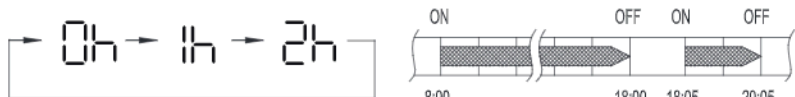

ex. If press select "2h" at 18:05, the air conditioner will delay to turn off at 20:05.

### Copy out the setting in one day into the other day.

A reservation made once can be copied to another day of the week. The whole reservation of the selected day of the week will be copied. The effective use of the copy mode ensures ease of making reservations.



During the weekly timer, press the Confirm button.



Press the button "∧" or "∨" to select the day to copy from.

## 11. Weekly Timer 1

- 3  Press the Copy button, the letter “CY” will be shown on the LCD.
- 

- 4  Press the button “ ^ ” or “ ∨ ” to select the day to copy to.
- 

- 5  Press the Copy button to confirm .

The  mark flashes quickly

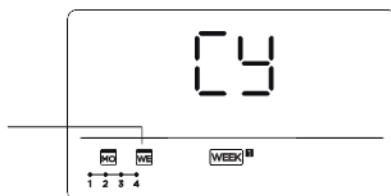

ex. Copy the setting of Monday to Wednesday

- 6 Other days can be copied by repeating step 4 and 5.
- 

- 7  Press the Confirm button to confirm the settings.
- 

- 8  Press the Back button to back to the weekly timer.

## 12. Weekly Timer 2

### 1 Weekly timer setting



Press Timer to select the **WEEK** and press Confirm.

### 2 Day of the week setting



Press “ $\vee$ ” or “ $\wedge$ ” to select the day of the week and then press CONFIRM.



### 3 ON timer setting of timer setting 1



Press “ $\wedge$ ” or “ $\vee$ ” to select the setting time. The setting time, mode, temperature and fan speed appear on the LCD. Press CONFIRM to enter the setting time process.

## 12. Weekly Timer 2

**IMPORTANT:** Up to 8 scheduled events can be set on one day.  
Various events can be scheduled in either MODE, TEMPERATURE and FAN speeds.

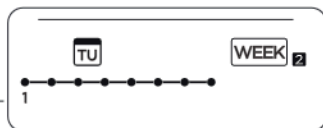

ex. Tuesday time scale 1

### 4 Time setting



Press “ ^ ” or “ v ” to set the time, then press CONFIRM.

### 5 Operation mode setting



Press “ ^ ” or “ v ” to set the operation mode then press CONFIRM.

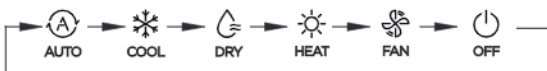

### 6 Room temperature setting



Press “ ^ ” or “ v ” to set the room temperature, then press CONFIRM.

**NOTE:** This setting is unavailable in the FAN or OFF modes.

## 12. Weekly Timer 2

### 7 Fan speed setting



Press “ ^ ” or “ v ” to set the fan speed then press CONFIRM.

**NOTE:** This setting is unavailable in the AUTO, DRY or OFF modes.

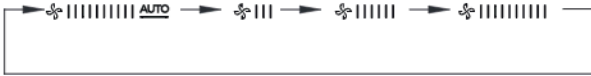

**8 Different scheduled events can be set by repeating steps 3 through 7.**

**9 Additional days, in a one-week period, can be set by repeating steps 3 through 8.**

**NOTE:** The weekly timer setting can be returned to the previous step by pressing BACK. The current setting is restored. The controller will not save the weekly timer settings if there is no operation within 30 seconds.

## 12. Weekly Timer 2

### WEEKLY timer operation

To start Press Timer to select the **WEEK**  , and then the timer starts automatically.



To cancel



Press the Power buttons for 2 seconds to cancel the timer mode.



The timer mode can also be canceled by changing the timer mode using Timer.

To set the DAY OFF (for a holiday)



After setting the weekly timer, press CONFIRM.



Press “” or “” to select the day of the week.

## 12. Weekly Timer 2

3



Press DAY OFF to create an off day.



ex.The DAY OFF is set for Wednesday

4 Set the DAY OFF for other days by repeating the steps 2 and 3.

5



Press BACK to revert to the weekly timer.

To cancel, follow the same procedures used for setup.

**NOTE:** The DAY OFF setting is cancelled automatically after the set day has passed.

### Copy out the setting in one day into the other day.



A scheduled event, made once, can be copied to another day of the week. The scheduled events of the selected day of the week will be copied. The effective use of the copy mode ensures the ease of reservation making.

1



In the weekly timer, press CONFIRM.



## 12. Weekly Timer 2

2  Press “ ^ ” or “ √ ” to select the day to copy from.  

---

3  Press COPY, the letters CY appear on the LCD.

---

4  Press “ ^ ” or “ √ ” to select the day to copy to.  

---

5  Press COPY to confirm.

The  mark flashes quickly

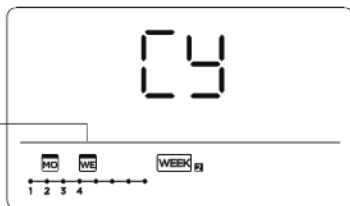

ex. Copy the setting of Monday to Wednesday

6 Other days can be copied by repeating steps 4 and 5.

---

7  Press CONFIRM to confirm the settings.

---



8  Press BACK to revert to the weekly timer.

## 12. Weekly Timer 2

### Delete the time scale in one day.

1  During the weekly timer setting, press CONFIRM.

---

2    Press “^” or “v” to select the day of the week and then press CONFIRM.

---

3   

Press “^” or “v” to select the setting time want to delete. The setting time, mode, temperature and fan speed appear on the LCD. The setting time, mode, temperature and fan speed can be deleted by pressing the DEL (day off).

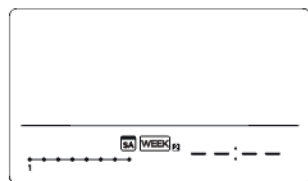

ex. Delete the time scale 1 in Saturday

## 13. Fault alarm handing

If the system does not properly operate except the above-mentioned cases or the above-mentioned malfunctions is evident, investigate the system according to the following procedures.

NO.	MALFUNCTION & PROTECTION DEFINE	DISPLAY DIGITAL TUBE
1	Error of communication between wire controller and indoor unit	E4b3

The error displayed on the wire controller are different from those on the unit. If error code appears, please check the <<Owner's and Installation Manual>>and<<SERVICE Manual>>.

## 14. Technical indication and requirement

EMC and EMI comply with the CE certification requirements.

## 15.Queries and settings



When the air conditioning unit is switch machine, long press “COPY” for 3 seconds , first display P:00, if connected to an indoor unit, display P:00, if connected to multiple indoor units, press “ ^ ”or “ ∨ ”to display P:01, P:02, and then press “Confirm” to enter the query indoor unit Tn(T1-T4) temperature and fan fault(CF), press“ ^ ”or “ ∨ ”to select.



Not operating keys 15 seconds or press “Back” or press “ON/OFF” drop out of query temperature.



When the air conditioning unit is off, into the query function of temperature, press“ ^ ”or “ ∨ ”to select SP, press “Confirm” to adjust the static pressure value.



When the air conditioning unit is off, into the query function of temperature, press“ ^ ”or “ ∨ ”to select AF, press “Confirm” into test mode, press “Back” or press “ON/OFF” or press “Confirm” drop out of test mode. In AF mode, 3-6 minutes test completion automatically exits, if the test process, press “Back” or press “ON/OFF” or press “Confirm”, the test exits will be interrupted.

## 15.Queries and settings

### Follow me function temperature compensation

^  
v  When the air conditioning unit is off, into the query function of temperature, press“ ^”or“ v”to select tF. The compensation temperature Range : -5-5°C. Press “Confirm” into setting state, press“ ^”or“ v” to select the temperature, then press “Confirm” to complete it.

tf

tf : compensation temperature

---

^  
v  When the air conditioning unit is off, into the query function of temperature, press“ ^”or“ v”to select tyPE. Press “Confirm” into setting state, press“ ^”or“ v”to select the type, then press “Confirm” to complete it.

tyPE

CH:       
AUTO COOL DRY HEAT FAN

HH:    
HEAT FAN

CC:     
COOL DRY FAN

NA:      
COOL DRY HEAT FAN

## 15.Queries and settings

### Set the highest and lowest temperature values

- ^
- ✓
- 
- When the air conditioning unit is off, into the query function of temperature, press“ ^ ”or “ √ ”to select tHI or tLo. Press “Confirm” into setting state, press“ ^ ”or “ √ ”to select the temperature, then press “Confirm” to complete it. The highest setting temperature range : 25-30°C The lowest setting temperature range: 16-24°C.

tHI  
tLO

tHI : Highest value setting function.

tLO : Minimum value setting function.

---

### Remote control function selection of wire controller

- ^
- ✓
- 
- When the air conditioning unit is off, into the query function of temperature, press“ ^ ”or “ √ ”to select rEC. ON or OF will be displayed in the temperature area to indicate whether it is valid or invalid.

rEC

When the selection is invalid, the wire controller does not process any remote-control signals.

Press “Confirm” into setting state, press “ ^ ” or “ √ ” to select, then press “Confirm” to complete it.

## 15.Queries and settings

### Two - line controller address selection

- ^      When the air conditioning unit is off, into the query  
v      function of temperature, press “ ^ ” or “ v ” to select  
     ADr, the temperature zone will display -- or A, B. Where  
    -- refers to the code setting of the wire controller.  
    Press “Confirm” into setting state, press “ ^ ” or “ v ”  
    to select , then press “Confirm” to complete it.

Adr

-- : The code setting  of the wire controller shall prevail.

Adr : The wire controller address setting.

---

### Restore factory Settings

- ^      When the air conditioning unit is off, into the query  
v      function of temperature, press“ ^ ”or “ v ”to select  
     INIt, the temperature zone displayed --.  
    Press “Confirm” into setting state, press“ ^ ”or “ v ”to  
    select to “ON” , then press “Confirm” to complete it.

INIt

INIt : Restore factory Settings .

## 15.Queries and settings

After the wire controller resumes the factory parameter setting, the rotating parameter setting is restored to 10 hours (the highest and lowest temperature are not set);  
The compensation of body temperature is uncompensated;  
COOL and HEAT/single COOL mode is restored to COOL and HEAT model;  
Restore the temperature range to the factory setting.  
Remote receiving function is restored to be effective;  
The address of the two-control first-line controller is restored to the code switch.

## 16. Wireless control connection

### **SAFETY PRECAUTION**

- Read the safety precautions carefully before installing the unit.
- Stated below are important safety issues that must be obeyed.  
Applicable system: IOS, Android. (Suggest: IOS 9.0 and above, Android 6.0 and above.)

### **NOTE**

- Due to special situation may occur, we explicitly claim below: Not all of the Android and IOS systems are compatible with APP. We will not be responsible for any issues as a result of the incompatibility.

#### Wireless safety strategy

- Smart kit only supports WPA-PSK/WPA2-PSK encryption and none encryption . WPA-PSK/WPA2-PSK encryption is recommended.

## 16. Wireless control connection

### CAUTION

- Please check the service website for more information.
- Smart Phone camera needs to be 5 million pixels or above to make sure scan QR code well.
- Due to different network situation, sometimes, request time-out could happen, thus, it is necessary to do network configuration again.
- Due to different network situation, control process may return time-out sometimes. If this situation occurs, the display between board and App may not be the same, please do not feel confused.

### NOTE

Company will not be liable for any issues and problems caused by Internet, Wireless Router and Smart Devices.

Please contact the original provider to get further help.

## 16. Wireless control connection

### **DOWNLOAD AND INSTALL APP**

On an app market (Google Play Store, Apple App Store), search for "NetHome Plus" and find the NetHome Plus app. Download and install it on your phone, you can also download the app by scanning the QR code below.



**Android**



**iOS**

- Please ensure your mobile device is connected to Wireless Network router. Also, the Wireless Network router has already connected to Internet before doing user registration and network configuration.
- Make sure your mobile device has already been connected to the Wireless Network which you want to use. Also, you need to forget other irrelative Wireless Network in case it influences your configuration process.



## 16. Wireless control connection

### NETWORK CONFIGURATION

#### CAUTION

- It is necessary to forget any other around network and make sure the Android or IOS device just connect to the Wireless Network you want to configure.
- Make sure the Android or IOS device Wireless Network function works well and can be connected back to your original Wireless Network automatically.

#### How to enter AP distribution network

Press the FUNC. button until the  icon is selected and then press the CONFIRM button. AP mode is activated if the  icon is blinked.

## 16. Wireless control connection

### Network configuration by Bluetooth scan

#### NOTE

Make sure the Bluetooth of your mobile device is working.

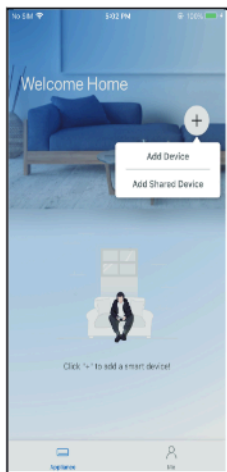

① Press “+ Add Device”.

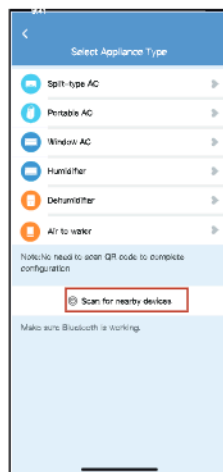

② Press “Scan for nearby devices”.

## 16. Wireless control connection

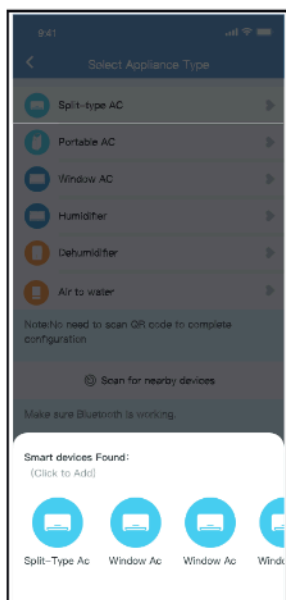

- ③ Wait smart devices to find, then click to add it.

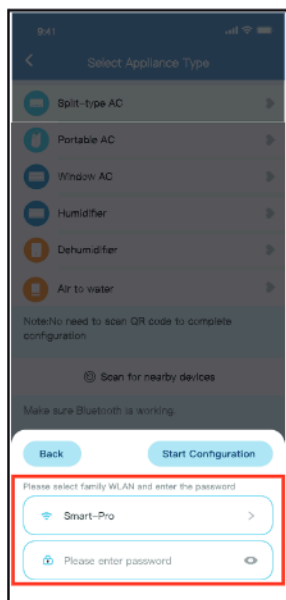

- ④ Select home Wireless, enter the password.

## 16. Wireless control connection

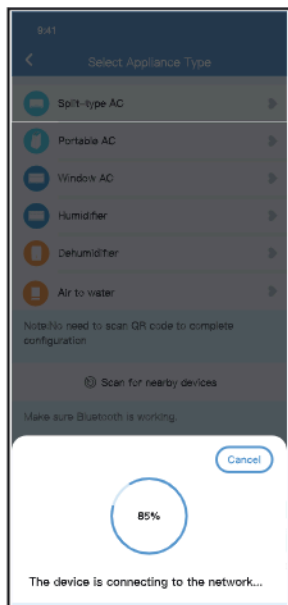

- ⑤ Wait connecting to the network.

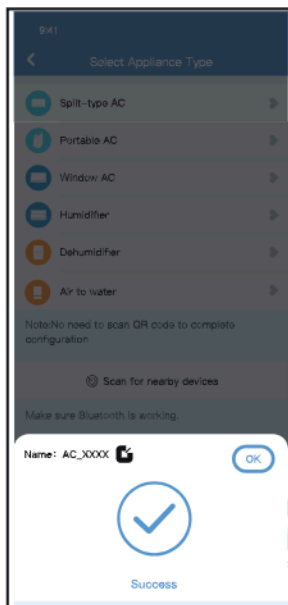

- ⑥ Configuration Success, you can modify the default name.

## 16. Wireless control connection

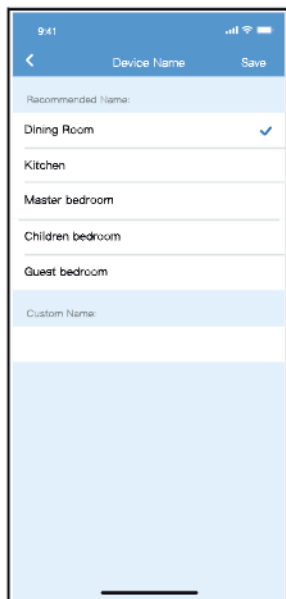

- ⑦ You can choose an existing name or customize a new name.

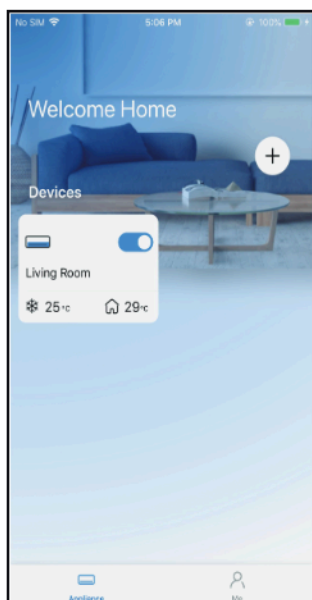

- ⑧ Bluetooth network configuration is successful, now you can see the device in the list.

## 16. Wireless control connection

### NOTE

- Make sure your devices are powered on.
- Keep your mobile phone close enough to your device when you are connecting network to your device.
- Connect your mobile phone to the wireless network at home, and make sure you know the password of the Wireless Network.
- Check if your router supports 2.4 GHz Wireless Network band and turn it on. If you are not sure whether the router supports 2.4 GHz band, please contact the router manufacturer.
- The device cannot connect to the Wireless Network that requires authentication, and it usually appears in public area such as hotels, restaurants, etc. Please connect to a Wireless that does not require authentication.
- It is recommended to use a Wireless Network name that only contains letters and numbers. If your Wireless Network name contains special characters, please modify it in the router.
- Turn off the WLAN+ (Android) or WLAN Assistant (iOS) function of your mobile phone when connecting network to your devices.
- In the case that your device connected to Wireless Network before but it needs to reconnect, please click "+" on app home page, and add your device again by the device category and model according to the instructions on app.

## 16. Wireless control connection

### **APP DECLARATION**

Hereby, we declare that this Smart kit is in compliance with the essential requirements and other relevant provisions of Directive 2014/53/EU. A copy of the full DoC is attached. (European Union products only)

### **CAUTION**

#### **Wireless Network module models: US-SK107, EU-SK107:**

FCC ID: 2ADQOMDNA21

IC: 12575A-MDNA21

This device complies with Part 15 of the FCC Rules and it contains license-exempt transmitter(s)/receiver(s) that comply with Innovation, Science and Economic Development Canada's license-exempt RSS(s).

Operation is subject to the following two conditions:

- (1) This device may not cause interference;
- (2) This device must accept any interference, including interference that may cause undesired operation of the device.

Only operate the device in accordance with the instructions supplied.

## 16. Wireless control connection

Changes or modifications to this unit not expressly approved by the party responsible for compliance could void the user's authority to operate the equipment.

This device complies with FCC radiation exposure limits set forth for an uncontrolled environment. In order to avoid the possibility of exceeding the FCC radio frequency exposure limits, human proximity to the antenna shall not be less than 20cm (8 inches) during normal operation.

## 16. Wireless control connection

### NOTE

This equipment has been tested and found to comply with the limits for a Class B digital device, pursuant to part 15 of the FCC Rules.

These limits are designed to provide reasonable protection against harmful interference in a residential installation. This equipment generates, uses and can radiate radio frequency energy and, if not installed and used in accordance with the instructions, may cause harmful interference to radio communications. However, there is no guarantee that interference will not occur in a particular installation. If this equipment does cause harmful interference to radio or television reception, which can be determined by turning the equipment off and on, the user is encouraged to try to correct the interference by one or more of the following measures:

- Reorient or relocate the receiving antenna.
- Increase the separation between the equipment and receiver.
- Connect the equipment into an outlet on a circuit different from that to which the receiver is connected.
- Consult the dealer or an experienced radio/TV technician for help.

## 16. Wireless control connection

### Breezeless function of dip switch.

#### NOTE

This feature is only available under cool mode.

This feature is for some models.

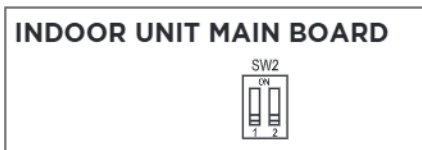

SW2 has 2 dip switch: SW2-1 and SW2-2

SW2-2 is to control the breezeless function.

