

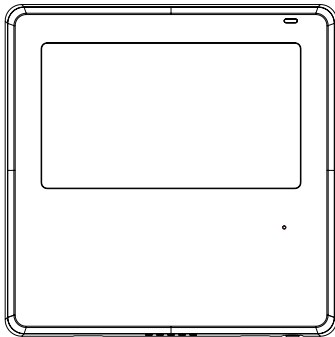

Comfort Extra Wired Remote Control Installation, Setup, and User's Manual



NOTE

Read this manual carefully before installing or operating your new Smart Thermostat. Make sure to save this manual for future reference.

Table of Contents

Safety Precautions	4
Battery Warning	5
Installation Accessory	8
Installation Method	9
Features & Functions Of The Wired Control	16
Control LCD Display Explanation.....	18
Control Button Explanation.....	19
Get Started	19
Operation	20
Timer Functions.....	27
Weekly Timer 1	29
Weekly Timer 2.....	33
Fault Alarm Handling	38
Technical Indication & Requirement.....	39
Queries & Settings.....	39
Wireless Control Connection	43

- This manual provides a detailed description of the precautions that should be taken into consideration during operation.
- To ensure the correct service of the wired controller, please read this manual carefully before using the unit.
- For the convenience of future reference, keep this manual after reading it.
- All the pictures in this manual are for explanatory purposes only. There may be slightly different from the wired controller you purchased (depending on the model). The actual shape shall prevail.

Safety Precautions

To ensure your safety and avoid damage to the device please read the safety precautions.

Look out for these icons. They indicate useful tips and important reminders.



WARNING

This symbol indicates the possibility of personnel injury or loss of life.

NOTE

Are prompts to take certain precautions or follow specific steps during the installation process.

⚠ WARNING

- Please entrust the distributor or professionals to install the unit.
- Installation by other persons may lead to imperfect installation, electric shock, or fire.
- Adhere to this installation manual.
- Improper installation may lead to an electric shock or fire.
- Reinstallation must be performed by professionals.
- Do not uninstall the unit randomly.
- Randomly uninstalling may lead to abnormal operation, overheating, or a fire in the air conditioner.

NOTE

- Do not install the unit in a location that is susceptible to leakage of flammable gases. If flammable gases escape and accumulate around the wire controller, a fire may occur.
- Do not operate with wet hands or let water enter the wire controller. Otherwise, an electric shock may occur.

- The wiring should adapt to the wire controller's current. Otherwise, electric leaks or overheating may occur and result in fire.
- The specified cables shall be applied in the wiring. No external force may be applied to the terminal. Otherwise, wire cutting and heating may occur and result in fire.

Battery Warning



WARNING: Contains a coin battery.

 **WARNING**

INGESTION HAZARD:

This product contains a button cell or coin battery.



BATTERY WARNING: KEEP OUT OF REACH OF CHILDREN

- If the battery compartment (if applicable) does not close securely, stop using the product and keep it away from children.
- If you think batteries might have been swallowed or placed inside any part of the body, seek immediate medical attention.

KEEP OUT OF REACH OF CHILDREN.

Swallowing can lead to chemical burns, perforation of soft tissue, and death.

Severe burns can occur within 2 hours of ingestion. Seek medical attention immediately.



WARNING

- **INGESTION HAZARD:** This product contains a button cell or coin battery.
- **DEATH** or serious injury can occur if ingested. A swallowed button cell or coin battery can cause **Internal Chemical Burns** in as little as 2 hours.
- **KEEP** new and used batteries **OUT OF REACH of CHILDREN.**
- **Seek immediate medical attention if a battery is suspected to be swallowed or inserted into any part of the body.**



WARNING:

This appliance can be used by children aged 8 years and older, as well as individuals with reduced physical, sensory, or mental capabilities, or those lacking experience and knowledge, provided they have received supervision or instruction on safe usage and understand the associated hazards.

Children should not play with the appliance. Cleaning and maintenance should not be performed by children without supervision (European Union countries). This appliance is not intended for use by individuals (including children) with reduced physical, sensory, or mental capabilities, or a lack of experience and knowledge, unless they have received supervision or instruction concerning the use of the appliance from someone responsible for their safety. Children must be supervised to ensure they do not play with the appliance.

- Remove and immediately recycle or dispose of used batteries according to local regulations and keep away from children. Do NOT dispose of batteries in household trash or incinerate.
- Even used batteries may cause severe injury or death. Call a local poison control center for treatment information.

- Non-rechargeable batteries are not to be recharged. Do not force discharge, recharge, disassemble, heat above $-4-158^{\circ}\text{F}$ ($-20-70^{\circ}\text{C}$), or incinerate. Doing so may result in injury due to venting, leakage, or explosion, resulting in chemical burns.
- Ensure the batteries are installed correctly according to polarity (+ and -).
- Do not mix old and new batteries, different brands or types of batteries, such as alkaline, carbon-zinc, or rechargeable batteries.
- Remove and immediately recycle or dispose of batteries from equipment not used for an extended period of time according to local regulations.
- Always completely secure the battery compartment. If the battery compartment does not close securely, stop using the product, remove the batteries, and keep them away from children.
- Battery type: CR2032
- Battery nominal voltage: 3.0 V

WARNING

If connecting power to existing wiring, an all-pole disconnection device which has at least 3/32 in. (3 mm) clearances in all poles, and have a leakage current that may exceed 10 mA, the residual current device (RCD) having a rated residual operating current not exceeding 30 mA, and disconnection must be incorporated in the existing wiring in accordance with the wiring rules.

Installation Accessory

Select the installation location

Don't install in a place with heavy oil, vapor, or sulfureted gas; otherwise, this product would be deformed, which would lead to system malfunction.

Preparation before installation

1. Please confirm that all the following parts have been supplied.

No.	Name	Qty.	Description
1	Wired Control	1	---
2	Installation and Owners Manual	1	---
3	Screws	3	M3.9*25 (For wall mounting)
4	Wall plugs	3	For wall mounting
5	Plastic screw bars	2	M4X25 (For mounting on a switch box)
6	Battery	2	For attaching to switch box
7	The connective wire bundle	1	Optional
8	Screw	1	M4*8 (For Mounting the connective wire bundle)

2. Prepare the following assemblies on the site.

No.	Name	Qty. (embedded into wall)
1	Wiring Tube (Insulating Sleeve and Tightening Screw)	1

Precautions for installing the wire controller

1. This manual provides the installation method for the wire controller. Please refer to the wiring diagram of this installation manual to wire the wire controller to the indoor unit.
2. The wire controller is working in low voltage loop circuit. Forbid to directly contact the cable of 220 V commercial electricity or 380 V high voltage,

and don't wire this kind of wire in the said loop; wiring clearance between configured tubes should be at the range of 11-13/16 ~ 19-13/16 in. (300~500 mm) or above.

3. The Shielded wire of the wire controller must be grounded firmly.
4. Upon finishing the wire controller connection, do not employ a megohmmeter to detect the insulation.

Installation Method

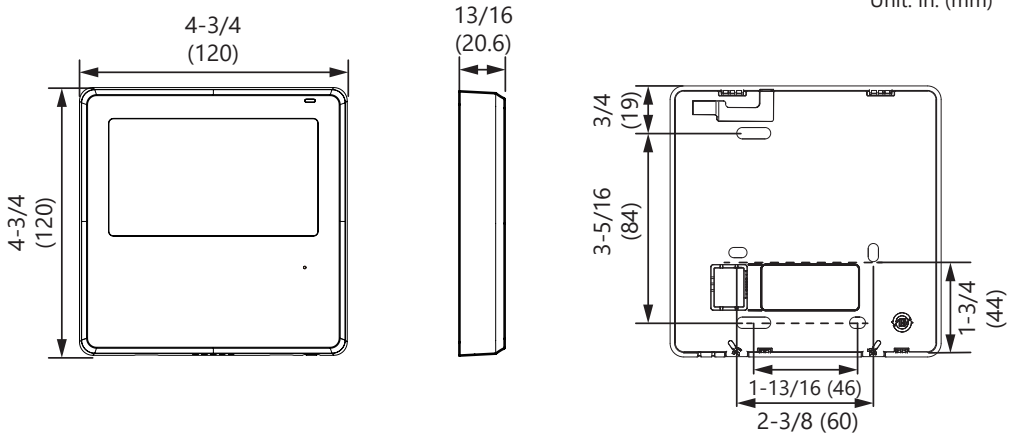

Wired Remote Control Dimensions

1. Insert a slot screwdriver into the slots in the lower part of the wire controller (2 places), and remove the upper part of the wire controller.

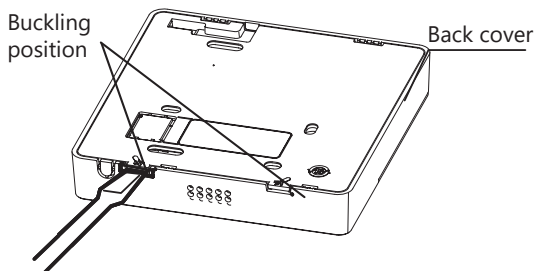

Remove The Back Cover Of Wired Controller

NOTE: Do not pry up and down; you can only rotate the screwdriver.

NOTE: The PCB is mounted in the upper part of the wire controller. Be careful not to damage the board with the slot screwdriver.

2. For exposed mounting, fasten the back plate on the wall with the 3 screws (ST3.9*25) and plugs.

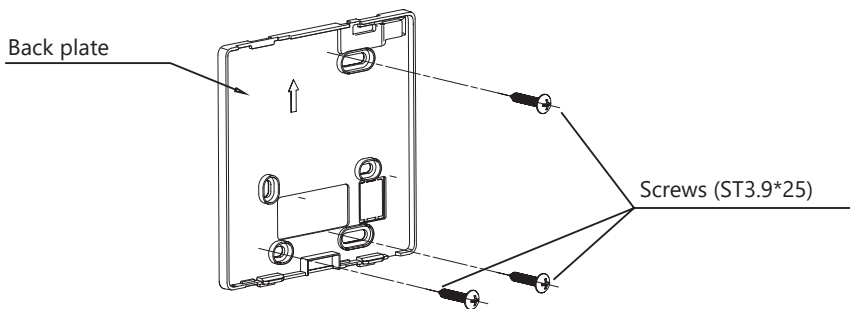

Fasten The Back Plate Of The Wired Controller

3. Use two M4*25 screws to install the back cover on the 86 switch box, and use one ST3.9*25 screw to attach to the wall.

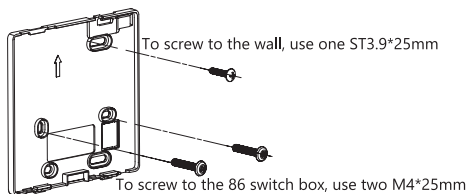

Install The Back Cover

NOTE

Put on a flat surface. Be careful not to distort the back plate of the wire controller by overtightening the mounting screws.

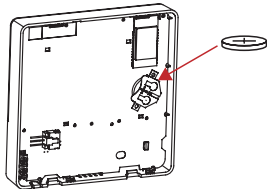

Battery installation

Please contact the professional technical after-sales service if the battery needs to be replaced.

4. Put the battery into the installation site and make sure the positive side of the battery is in accordance with the positive side of the installation site.
5. Set the time correctly on the first operation. Batteries in the wired controller can maintain timing under a power failure, which ensures the time is kept right. When the power is restored, if the time displayed is not correct, it means the battery is dead and needs to be replaced.

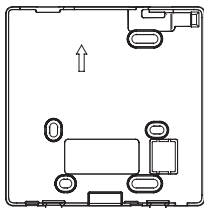
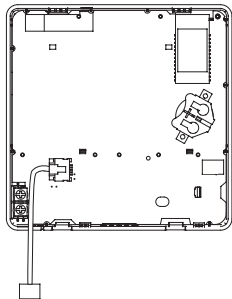
A

1-3/4 in.
(44 mm)

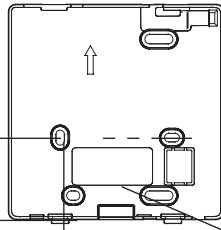
B

2-3/8 in.
(60 mm)

Wiring Hole

Switch Box

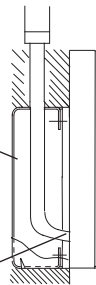
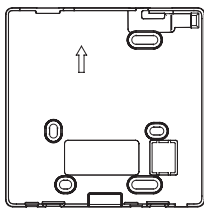
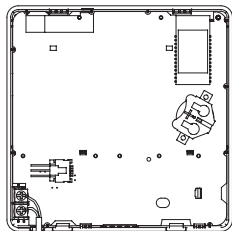
**Model A****A**

1-3/4 in.
(44 mm)

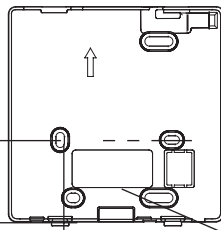
B

2-3/8 in.
(60 mm)

Wiring Hole

Switch Box

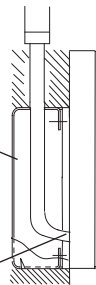
**Model B**

1-
HA HB

Wire The Indoor Unit

Model A

Connect the wire from the mainboard of the indoor unit to a connecting cable. Then connect the other side of the connecting cable to the wire controller.

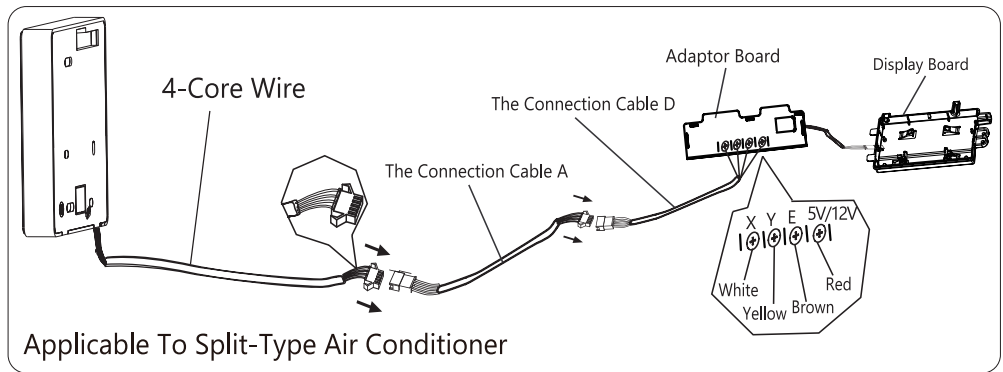
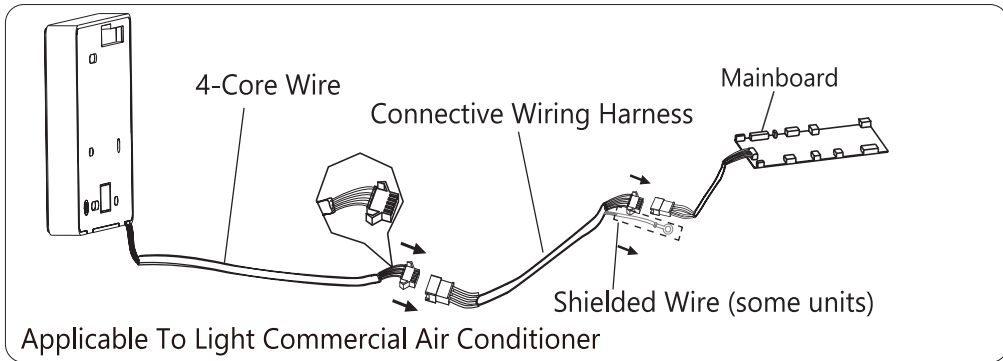

Model B

1 Indoor unit

Notch the part for the wiring to pass through with nippers, etc. Connect the terminals on the wired controller (HA, HB), and the terminals of the indoor unit (HA, HB). (HA and HB do not have polarity.)

NOTE

DO NOT allow water to enter the wire controller. Use the trap and putty to seal the wires. Connecting wires must be fixed reliably and cannot be pulled.

For some units, the wire controller connects to the unit HA and HB ports HA and HB ports. There is no polarity between HA and HB.

The main/secondary wire controller can be used to enable two wire controllers to control one unit, and the wire controllers connect to the unit's HA and HB ports through the HA and HB ports on the controller. There is no polarity between HA and HB.

NOTE

The wired controller with a wireless function does not have this function.

For some units, one wire controller can support multiple units (a maximum of 16 units). In this case, the wire controller and unit need to be connected to

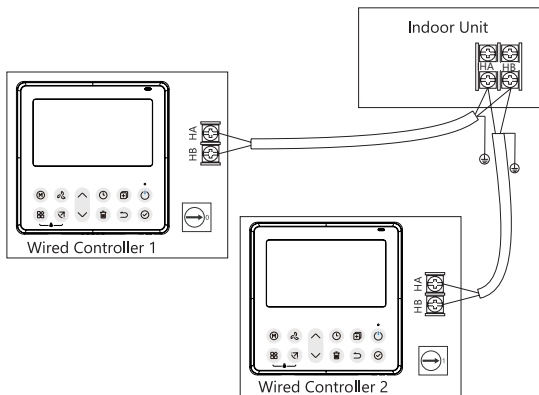
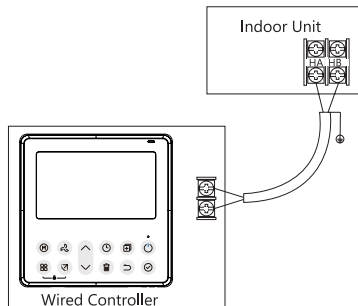

the HA and HB ports at the same time. In group control, there will be no error displayed on the wired controller.

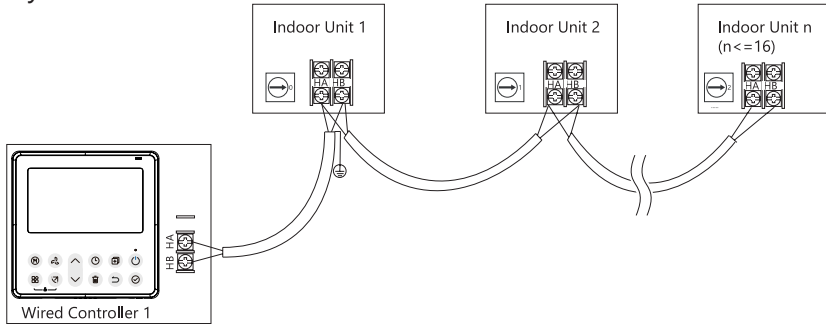

Seal all of the wiring openings with putty.

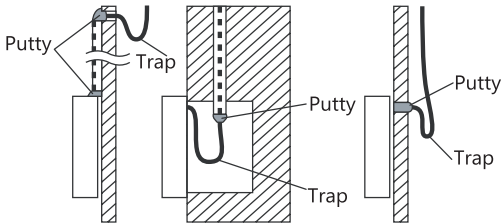

Wiring Specification

12 V
32°F~113°F (0°C~45°C)
RH 40%~RH 90%

NOTE

It is suggested use a connective wire that is 20 ft. (6 m) in length.

After adjusting the upper case and then buckling the upper case, avoid clamping the wiring while installing the cover.

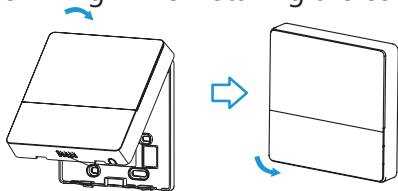

Reattach the upper part of the wired controller

Features & Functions Of The Wired Control

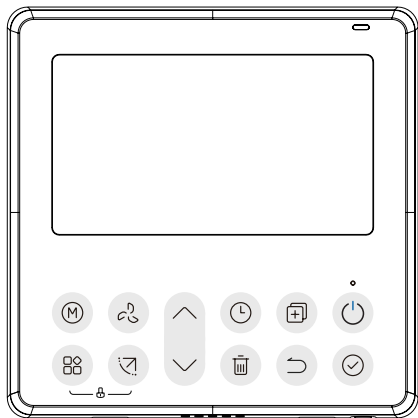

Feature:

- LCD display.
- Malfunction code display: it can display the error code, helpful for service.
- 4-way wire layout design, no raised part at the back, a more convenient to place the wires and install the device.
- Room temperature display.
- Weekly Timer.

Function:

- Mode: Choose Auto-Cool-Dry- Heat -Fan
- Fan speed: Auto/Low/Med/High speed
- Swing (on some models)
- Timer ON/OFF
- Temp setting

- Weekly timer
- Follow me
- Turbo
- 24-hour System
- 12-hour System
- Auto-restart
- Individual louver control (on some models)
- Automatic airflow test
- Rotation & Back-up Dual Control
- Group Control
- Child Lock
- LCD display
- Clock

Control LCD Display Explanation

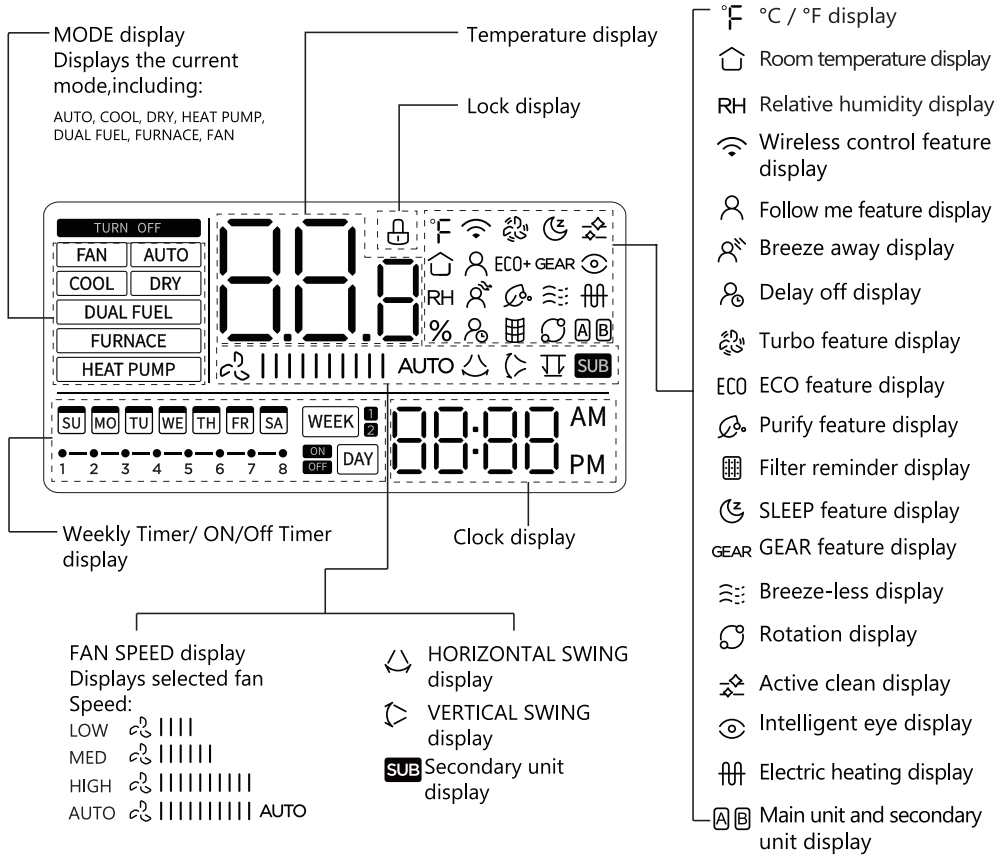



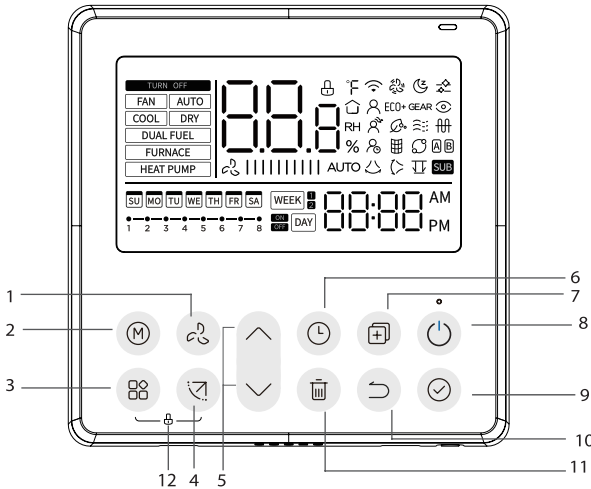

Control Button Explanation



1. FAN SPEED
2. MODE
3. FUNCTION
4. SWING
5. ADJUST
6. TIMER
7. COPY
8. POWER
9. CONFIRM
10. BACK
11. DAY OFF/DELAY
12. CHILD LOCK

Get Started

Set The Current Day And Time Steps

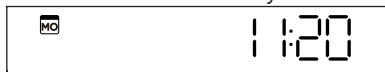

- 1  Press the Timer button for 2 seconds or more. The timer display will flash.
- 2  Press the button “^” or “v” to set the date. The selected date will flash.
 
- 3  The date setting is finished and the time setting is prepared after pressing the Timer button or CONFIRM button or there is no button to press within 10 seconds.

4  Press the button “^” or “v” to set the current time. 4 Press repeatedly to adjust the current time in 1-minute increments. Press and hold to adjust the current time continuously.



ex. Monday 11:20

5  The setting is done after pressing the CONFIRM button, or after 10 seconds.

6   Time scale selection
Press the buttons “⌚” and “🕒” for 2 seconds will alternate the clock time display between the 12h & 24h scale.

Operation

To start/stop system operation

 Press the POWER button

8-degree heating function

 When the heating mode temperature is 60°F (16 °C) or the set minimum temperature, press the key twice within 1 second to turn on the 8°C heating function. When the 8°C heating function is enabled, Follow Me, SLEEP, Turbo, and Daily Timer features are cancelled.

To set the operation mode

Operation mode setting (Heat mode is invalid for cool-only type units).

 Press this button to select the operation mode:

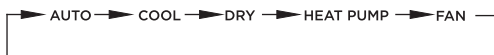

If the indoor unit has Aux. (Emergent heating) mode and Heat+Aux. mode, press the button to select the operation mode:

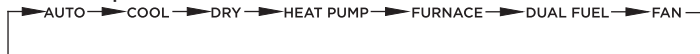

If the indoor unit has Aux. (Emergent heating) mode, but no Heat+Aux. mode, press the button to select the operation mode:





- When the mode is selected as FURNACE mode, the default fan speed is Auto. The Sleep, 8-degree heating, Turbo, and Rotation functions are not available in FURNACE mode.
- When the mode is selected as DUAL FUEL mode, you can adjust the fan speed. The Turbo and Rotation functions are disabled.

NOTE

1. The specific available mode depends on the unit. If the unit does not have a particular mode, it cannot be activated.
2. In emergency heat (or electric heat) mode or heat & emergency heat (or electric heat) mode, if the unit supports adjusting the fan speed, the fan speed level can be adjusted.

Room temperature setting

-  Lower Press the button “^” or “v” to set the room temperature. Indoor Setting Temperature Range: 50/60/62~86°F (10/16/17~30°C) or 68~82°F (20~28°C). (Model dependent)
-  Raise



°C & °F scale selection (on some models)

Pressing the buttons “^” and “v” for 3 seconds will alternate the temperature display between the °C & °F scales.

Fan speed setting



Press the Fan speed button to set the fan speed. (This button is unavailable under Auto or Dry mode.)

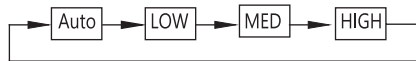

When stepless speed regulation is supported, press the fan speed key to cycle through:

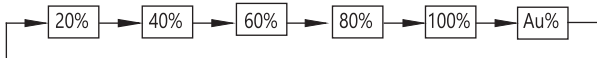

Press the buttons “M” and “CS” together for 3 seconds to turn on or turn off the keypad tone.

Child lock function

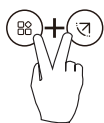

Press the buttons “ ” and “CS” for 3 seconds to activate the child lock function and lock all buttons on the wire controller. You can't press the button to operate and receive the remote control signal after the child lock is activated.

Press these two buttons again for 3 seconds to deactivate the child lock function.

When the child lock function is activated, the “ ” mark appears.

Swing function (For the units with horizontal & vertical swing features only)

1. Up-Down swing



Press the SWING button to start the up-down swing function.

The “ ” mark appears. Press it again to stop.

2. Left-Right swing

Press the Swing button for 2 seconds to start Left-Right swing function.

The “ ” mark appears. Press it for 2 seconds again to stop.

PTC function (on some models)





In heating operation, for the units with an electric heating feature, press this button to activate the electric heating function. When the PTC function is activated, the “” mark appears.

NOTE

The electric auxiliary heating function of the AHU model is switched by the MODE button, and the FUNC. button is a turbo function.

Follow me function indicator

Press the FUNC. button to select whether the room temperature is detected at the indoor unit or the wired controller.

When the follow me function “ ” indicator appears, the room temperature is detected by the wire controller.

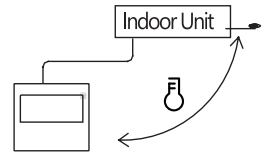

Press the FUNC. button and select the “” icon. At this point, the icon will flash. Press the confirm button to turn the follow me function on or off.

Intelligent eye display

1. This function is valid in auto mode, cool mode, and heat mode.
2. When the indoor unit sending wire controller has the smart eye function, press the function key to select the smart eye icon, press the OK key to turn on the smart eye, and light up the smart eye icon at the same time; when the smart eye is turned off, the smart eye icon goes out.
3. Shutdown, switch mode, turn on self-cleaning, and turn on the 8-degree heating function will automatically cancel the smart eye function.

Filter reset function

After the indoor unit sends the wire controller filter usage time, the filter cleaning prompt icon lights up, and press the function key to select the filter

cleaning prompt icon, and press the OK key to reset the filter screen time. The filter cleaning reminder icon goes out.

Humidity setting function

1. When the indoor unit sending wire controller has dual control function of temperature and humidity, in dehumidification mode, press the function key to select the RH icon, press the confirm key to enter the humidity control mode, the RH icon flashes, press the up and down keys to adjust the humidity, the setting range is OFF->35%~85%, adjusted with 5% humidity. Exit the humidity adjustment state after 5 seconds of inactivity.
2. After entering the humidity control mode, press the up and down keys to adjust the set temperature and display the set temperature for 5 seconds, and then restore the set humidity display.
3. After switching the mode, exit the humidity control mode.

GEAR function

1. When the indoor unit sending wire controller has the GEAR function, in the boot cooling mode, press the function key to select the GEAR icon, press the confirm key to enter the GEAR control mode, and first display the current GEAR status.
2. 50%->75%->OFF can be switched by the up and down keys within 5 seconds. After 5 seconds, the set temperature will be displayed. press the up and down keys to adjust the set temperature.
3. Turn off, switch to mode, or turn on sleep, ECO, strong, self-cleaning functions to cancel the GEAR function.

Rotation & Back-up indication

When there are two units, press the button to select the rotating function, and press "Confirm" to turn on or off the rotating function.

1. Press "Confirm" to set the rotating time, then press the button "^" or "v" to set time. Setting time Range: 1~99h, the default time is 10 hours.

2. Set high temperature and co-open temperature. The available temperature range of high-temperature co-open is 79~90°F (26~32°C). When it shows "--", it means the low-temperature function is turned off. When the ambient temperature is 79~90°F (26~32°C), and the high-temperature co-open temperature is valid, when the temperature sensor of the wire controller detects that the indoor temperature is greater than or equal to the setting high-temperature co-open temperature, both air conditioners will operate in COOL mode until the indoor temperature detected by the wire controller is less than the setting high-temperature co-open temperature minus 35°F (2°C). At this point, one unit will continue to operate according to the set temperature and mode, while the other unit will be turned off.
NOTE: When both units are running in COOL mode, the indoor unit's set temperature will be fixed at 75°F (24°C).
3. Set the low temperature. The available temperature range of low temperature co-open is 41~59°F (5~15°C). When it shows "--", it means the low-temperature co-open temperature function is turned off. When the ambient temperature is 41~59°F (5~15°C), and the setting low-temperature co-open temperature is valid, when the temperature sensor of the wired controller detects that the indoor temperature is less than or equal to the setting low-temperature co-open temperature, both air conditioners will operate in HEAT mode until the indoor temperature detected by the wired controller is 2°C higher than the setting low-temperature co-open temperature. At this point, one unit will continue to operate according to the set temperature and mode, while the other unit will be turned off.
NOTE: When both units are operating in HEAT mode, the indoor unit's set temperature will be fixed at 36°F (24°C).
4. Set which machine will run first. Select A or B.
5. After this function is turned on, if the air conditioner is running at the

set hour, it will automatically turn on another air conditioner and turn off the current air conditioner. Press the POWER button to switch to another one immediately. A or B icons flicker to indicate the corresponding air conditioning failure. Automatically switch to another machine when the running time is reached or a machine failure occurs.

Timer Functions

WEEK

WEEKLY timer

Use this timer function to set operating times for each day of the week.

ON

DAY

On timer

Use this timer function to start the air conditioner operation. The timer operates, and the air conditioner operation starts after the time has passed.

OFF

DAY

Off timer

Use this timer function to stop the air conditioner's operation. The timer operates, and the air conditioner operation stops after the time has passed.

ON

OFF

DAY

On and Off timer

Use this timer function to start and stop the air conditioner operation. The timer operates, and the air conditioner operation starts and stops after the time has passed.

NOTE

You can set "day off" to automatically start with the most recent timer settings each time the device is powered on by configuring dy:1 and dy:2 in engineering mode. For more details, refer to the description of the engineering mode settings.

To set the On or Off TIMER



1. When "day on" or "day off" is selected, the [ON] [OFF] icon will flash, and the temperature display area will also flash.

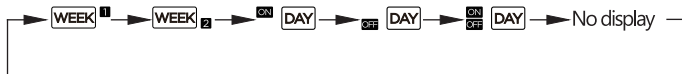

2. Use the "∨" or "∧" keys to select the timer duration, in 0.5-hour increments.



3. Press the confirm key to activate the timer and complete the setting.

Set "day on off"



1. When "day on off" is selected, the [ON] icon will flash, and the [OFF] icon will light up.



2. Use the "∨" or "∧" keys to select the "on" timer duration, in 0.5-hour increments.



3. Press the confirm key to activate the "on" timer duration; at this point, the [ON] icon will light up, and the [OFF] icon will flash.



4. Use the "∨" or "∧" keys to select the "off" timer duration, in 0.5-hour increments.



5. Press the confirm key to activate the "off " timer duration and complete the setting.

NOTE

The secondary wired controller cannot set the timer.

Weekly Timer 1



1. Weekly timer setting

Press the Timer button to select the "WEEK" and then press the Confirm button to confirm.



2. Day of the week setting

Press the button "∨" or "∧" to select the day of the week and then press the Confirm button to confirm the setting.



3. ON timer setting of timer setting 1

Press the button "∨" or "∧" to set the time of the On timer, and then press the Confirm button to confirm the setting.



ex. Tuesday time scale 1

Up to 4 timer settings can be saved for each day of the week. It is convenient if the WEEKLY TIMER is set according to the user's lifestyle.

4. Off timer setting of timer setting 1

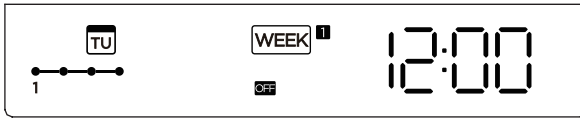

ex. Tuesday time scale 1

5. Different timer settings can be set by repeating steps 3 to 4.

6. Other days in one week can be set by repeating steps 2 to 4.

NOTE

The weekly timer setting can be returned to the previous step by pressing the Back button. The time of the timer setting can be deleted by pressing the Day off button. The current setting will be restored, and the weekly timer setting will automatically be reset when there is no operation for 30 seconds.

WEEKLY timer operation

To activate WEEKLY TIMER operation



Press the Timer button while "WEEK" is displayed on the LCD.

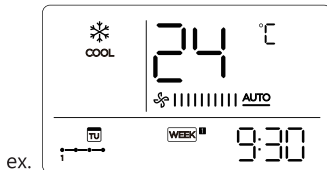

To deactivate WEEKLY TIMER operation



Press the Timer button while "WEEK" is disappearing from the LCD.

To turn off the air conditioner during the weekly timer



1. If you press the Power button once and quickly, the air conditioner will turn off temporarily. And the air conditioner will turn on automatically until the time of On timer.

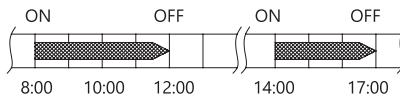

ex. If you press the POWER button once and quickly at 10:00, the air conditioner will turn on at 14:00.

2. When you press the Power button for 2 seconds, the air conditioner will turn off completely, at the same time canceling the timing function.

To set the DAY OFF (for a holiday)



1. During the weekly timer, press the Confirm button.



2. Press the button " ^ " or " ∨ " to select the day in this week.



3. Press the Day off button to set the DAY OFF.

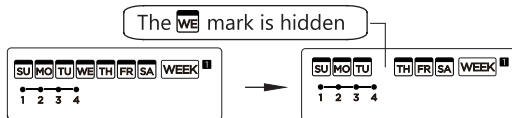

ex. The DAY OFF is set for Wednesday

4. The DAY OFF can be set for other days by repeating steps 2 and 3.



5. Press the Back button to back to the weekly timer.

To cancel: Follow the same procedures as those for setup.

NOTE

The DAY OFF setting is cancelled automatically after the set day has passed.

DELAY function

 During the weekly timer, press the FUNC. button, select the delay function and press the Confirm button, display "0h" "1h" "2h" and wait 3 seconds to confirm. When the delay function is activated, the "⌚" mark appears. The delay function can only be enabled in Weekly Timer 1 and Weekly Timer 2.

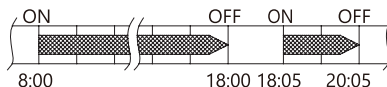
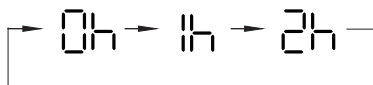

ex. If you press select "2h" at 18:05, the air conditioner will delay turning off until 20:05.

Copy the setting from one day to another day.

A reservation made once can be copied to another day of the week. The whole reservation of the selected day of the week will be copied. The effective use of the copy mode ensures ease of making reservations.



1. During the weekly timer, press the Confirm button.



2. Press the button "∧" or "∨" to select the day to copy from.



3. Press the Copy button, and the letter "CY" will be shown on the LCD.



4. Press the button “^” or “v” to select the day to copy to.



5. Press the Copy button to confirm.

The **WE** mark flashes quickly

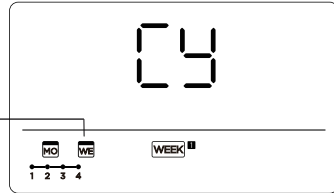

ex. Copy the setting from Monday to Wednesday

6. Other days can be copied by repeating steps 4 and 5.



7. Press the Confirm button to confirm the settings.



8. Press the Back button to go back to the weekly timer.

Weekly Timer 2

1. Weekly timer setting



Press Timer to select the “**WEEK**” and press Confirm.

2. Day of the week setting

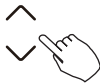

Press “v” or “^” to select the day of the week and then press CONFIRM.



3. ON timer setting of timer setting 1

- ^ Press " ^ " or " v " to select the setting time. The setting time, mode, temperature, and fan speed appear on the LCD. Press CONFIRM to enter the setting time process.



IMPORTANT: Up to 8 scheduled events can be set on one day. Various events can be scheduled in either MODE, TEMPERATURE, or FAN speeds.

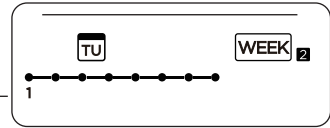

ex. Tuesday time scale 1

4. Time setting

- ^ Press " ^ " or " v " to set the time, then press CONFIRM.



5. Operation mode setting

- ^ Press " ^ " or " v " to set the operation mode, then press CONFIRM.



6. Room temperature setting

- ^ Press " ^ " or " v " to set the room temperature, then press CONFIRM.



NOTE

This setting is unavailable in the FAN or OFF modes.

7. Fan speed setting

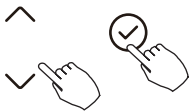

Press “^” or “v” to set the fan speed, then press CONFIRM.



NOTE

This setting is unavailable in the AUTO, DRY, or OFF modes.

8. Different scheduled events can be set by repeating steps 3 through 7.
9. Additional days, in a one-week period, can be set by repeating steps 3 through 8.

NOTE

The weekly timer setting can be returned to the previous step by pressing BACK. The current setting is restored. The controller will not save the weekly timer settings if there is no operation within 30 seconds.

WEEKLY timer operation

To start

 Press the Timer to select the “WEEK” and then the timer starts automatically.

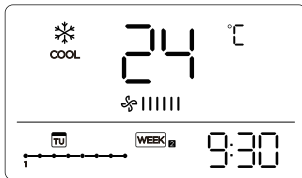

ex.

To cancel



Press the Power button for 2 seconds to cancel the timer mode.



The timer mode can also be canceled by changing the timer mode using the Timer.

To set the DAY OFF (for a holiday)



1. After setting the weekly timer, press CONFIRM.



2. Press “^” or “v” to select the day of the week.



3. Press DAY OFF to create an off day.



ex. The DAY OFF is set for Wednesday

4. Set the DAY OFF for other days by repeating steps 2 and 3.



5. Press BACK to revert to the weekly timer.

To cancel, follow the same procedures used for setup.

NOTE

The DAY OFF setting is cancelled automatically after the set day has passed.

Copy out the setting from one day to another

A scheduled event, made once, can be copied to another day of the week. The scheduled events of the selected day of the week will be copied. The effective

use of the copy mode ensures the ease of making reservations.



1. In the weekly timer, press CONFIRM.



2. Press "∧" or "∨" to select the day to copy from.



3. Press COPY, the letters CY appear on the LCD.



4. Press "∧" or "∨" to select the day to copy to.



5. Press COPY to confirm.

The  mark flashes quickly

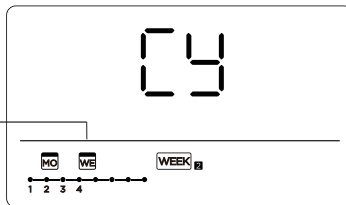

ex. Copy the setting from Monday to Wednesday

6. Other days can be copied by repeating steps 4 and 5.



7. Press CONFIRM to confirm the settings.



8. Press BACK to revert to the weekly timer.

Delete the time scale in one day



1. During the weekly timer setting, press CONFIRM.



2. Press "∧" or "∨" to select the day of the week and then press CONFIRM.



3. Press "∧" or "∨" to select the setting time you want to delete. The setting time, mode, temperature, and fan speed appear on the LCD. The setting time, mode, temperature, and fan speed can be deleted by pressing the DEL (day off).

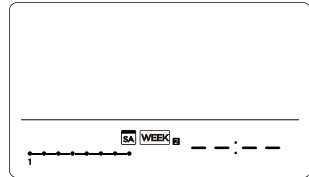
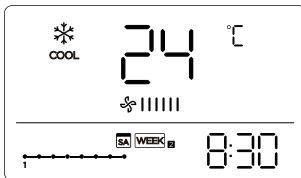

ex. Delete the time scale 1 on Saturday

Fault Alarm Handling

If the system does not properly operate except in the above-mentioned cases or the above-mentioned malfunctions are evident, investigate the system according to the following procedures.

No.	Malfunction & Protection Define	Display Digital Tube
1	Error in communication between the wired controller and the indoor unit.	Eh63

The error displayed on the wired controller is different from those on the unit.



If an error code appears, please check the Owner's and Installation Manual and the SERVICE Manual.

Technical Indication & Requirement



EMC and EMI comply with the CE certification requirements.

Queries & Settings

-  When the air conditioning unit is ON or OFF machine, Long press "COPY" for 3 seconds, first display P:00, if connected to an indoor unit, display
- ^ P:00, if connected to multiple indoor units, press " ^ " or " v " to display P:01, P:02, and then press "Confirm" to enter the query indoor unit Tn
 - v (T1~T4) temperature and fan fault (CF), press " ^ " or " v " to select.
-

-   Not operating keys for 15 seconds or pressing "Back" or pressing "ON/OFF" drops out of the query and setting.
-

- ^ When the air conditioning unit is off, into the query function of temperature, press " ^ " or " v " to select SP, press "Confirm" to adjust the static pressure value.
- v 
-

- ^ When the air conditioning unit is off, in the query function of temperature, press " ^ " or " v " to select AF, press "Confirm" into test mode and flash "ON", press "Back" or press "ON/OFF" or press "Confirm" drop out of test mode. In AF mode, 3~6 minutes test completion automatically exits. When it exits, it should not display
- v  
- or pressing "Confirm", the test will be interrupted.
-

Follow Me Function Temperature Compensation

- ^ When the air conditioning unit is off, into the query function of temperature, press " ^ " or " v " to select tF. The compensation
- v  temperature Range: -9~9°F (-5~5°C).

tF

Press "Confirm" into the setting state, press " ^ " or " v " to select the temperature, then press "Confirm" to complete it.
tF: compensation temperature

- ^ When the air conditioning unit is off, into the query function of temperature, press " ^ " or " v " to select the type.
- v  Press "Confirm" into the setting state, press " ^ " or " v " to select the type, then press "Confirm" to complete it.

TYPE

CH: AUTO COOL DRY HEAT PUMP FAN

HH: HEAT PUMP FAN

CC: COOL DRY FAN

NA: COOL DRY HEAT PUMP FAN

Set The Highest And Lowest Temperature Values

- ^ When the air conditioning unit is off, into the query function of temperature, press " ^ " or " v " to select tHI or tLO.
- v  Press "Confirm" into the setting state, press " ^ " or " v " to select the temperature, then press "Confirm" to complete it.

tHI
tLO

The highest setting temperature range: 77~86°F (25~30°C). The lowest setting temperature range: 61~75°F (16~24°C).

tHI: Highest value setting function.

tLO: Minimum value setting function.

Remote Control Function Selection Of The Wired Controller

- ^ When the air conditioning unit is off, into the query function of temperature, press " ^ " or " v " to select rEC. ON or OF will be displayed in the temperature area to indicate whether it is valid or invalid.
- v 

rEC

When the selection is invalid, the wire controller does not process any remote control signals.

Press "Confirm" to set the state, press " ^ " or " v " to select, then press "Confirm" to complete it.

Two-Line Controller Address Selection

- ^ When the air conditioning unit is off, to the query function of temperature, press " ^ " or " v " to select Adr, the temperature zone will display -- or A, B. Where -- refers to the code setting of the wire controller.
- v 

Adr

Press "Confirm" to set the state, press " ^ " or " v " to select , then press "Confirm" to complete it.

-- : The code setting "  " of the wire controller shall prevail.

Adr : The wire controller address setting.

Restore Factory Settings

- ^ When the air conditioning unit is off, into the query function of temperature, press " ^ " or " v " to select INIt, the temperature zone displayed --.
- v 

INIt

Press "Confirm" to set the state, press " ^ " or " v " to select "ON", then press "Confirm" to complete it.

INIt : Restore factory Settings.

After the wire controller resumes the factory parameter setting, the rotating parameter setting is restored to 10 hours (the highest and lowest temperatures are not set); The compensation of body temperature is uncompensated; COOL and HEAT/single COOL mode are restored to COOL and HEAT model; Restore the temperature range to the factory setting. Remote receiving function is restored to be effective; The address of the two-control first-line controller is restored to the code switch.

Set Day Off To Automatically Start On Power On:

1. Use the up or down key to select dy:1, displaying the current setting value.
2. Press the confirm key to enter the option for enabling the Day Off auto-start function. The setting value will start flashing.
3. Use the up or down key to change the setting value. A value of 1 enables the function, while a value of 0 disables it.
4. Press the confirm key to apply the setting. This will take you to the maximum timer setting option for Day Off, dy:2, displaying the current setting value. The value represents the timer duration in hours, with increments of 0.5 hours.
5. Use the up or down key to change the setting value.
6. Press the confirm key to apply the setting and complete the configuration.

NOTE

Once the Day Off auto-start function is enabled, the device will automatically start the Day Off function with the last set timer duration each time it is powered on.

Set Up Network Time Synchronization:

1. Use the up or down key to select NTP and display the current setting.
2. Press the confirm key to enter the function setting.
3. Use the up or down key to choose the setting value, where 0 means turning off the network time synchronization function and 1 means turning it on.

4. Press confirm to apply the setting and complete the setup.

Wireless Control Connection

NOTE

Applicable to the unit with wireless control function only.



1. Specification

This device complies with the essential requirements and other relevant provisions of Directive 2014/53/EU. (European Union products only)

- Wireless Module Model: EU-SK107, US-SK107, EU-SK110, US-SK110
- Antenna Type: Printed PCB Antenna
- Wireless: 2400 - 2483.5MHz, TX Power: < 20dBm
- Operation Temperature: 0°~45°C/32°~113°F
- Operation Humidity: 10%~85%
- Power Input: DC 5V/500mA
- BLE: 2402 - 2480MHz, TX Power: < 10dBm

2. Precautions

- App Compatibility:
 - The app is available for both iOS and Android; however, older versions may no longer be compatible. Please keep the app updated with the latest version. Midea makes no guarantee of compatibility and is not responsible for issues arising as a consequence thereof.
 - The app is subject to updates without prior notice for the improvement of product functionality.
- Wireless Security:
 - The Smart Kit supports the following security protocols: WPA-PSK / WPA2-PSK / WPA3-SAE
 - It may be used with or without encryption, although encryption is strongly recommended.
- Connectivity:

- Network issues may occasionally cause timeouts. The unit display and the app may become unsynchronized, but this will resolve itself when the network is restored.
 - Should the network remain unavailable, it might be necessary to rerun the configuration process.
 - Change in the wireless network will require reconfiguration of the device.
 - Configuration:
 - The actual network configuration process may vary
 - slightly from the manual.
 - Please check the service website for more information.
 - Restore to factory settings:
 - When the user deletes the device from the APP, the module automatically restores to factory settings.
3. Use Your Appliance with the SmartHome App
-  Ensure that your mobile phone is connected to the home wireless network, the 2.4GHz band wireless signal is enabled on your wireless router, and you know the network password.
 -  Turn on Bluetooth on your phone, and the device must also be powered up.

Network Configuration

CAUTION:

- It is necessary to forget any other around networks and make sure the Android or IOS device connects to the Wireless Network you want to configure.
- Make sure the Android or IOS device Wireless Network function works well and can be connected back to your original Wireless Network automatically.

How To Enter The AP Distribution Network

Press the FUNC. button until the "📶" icon is selected, and then press the CONFIRM button. AP mode is activated if the "📶" icon blinks.

1 Download SmartHome App

Scan the QR code below to download the SmartHome app from the App Store or search for it directly on the Google Play Store or Apple's App Store.

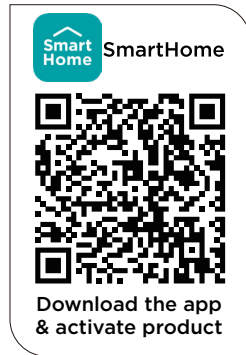

2 Register or Login account

Open the App and create a user account, if you already have one, just log in.

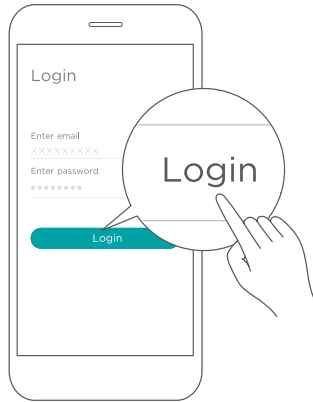

3 Connecting the device

1. When you log in, you may see the message "Smart devices discovered nearby". Tap to add your device.
2. If no such message appears, proceed as follows:
Tap on "+" and select your device in the list of nearby available devices.
If your device is not listed, please add your device manually, first selecting the device category, e.g., Portable AC.

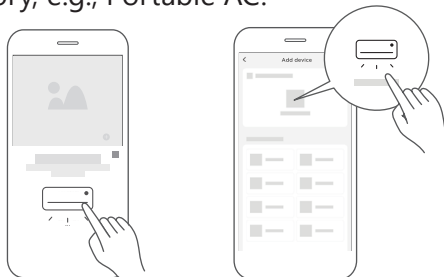

- Follow the steps in the app to connect your device to the wireless network.
If your device fails to connect, follow the additional instructions in the app.



4 Controlling the device

After pairing successfully, a card will be created for the device in the SmartHome app.

Shortcuts for basic functions will appear on the card, such as changing the temperature or switching the device on or off.

Tapping on the card will reveal additional features and settings. The actual UI design may look different from examples due to app updates.

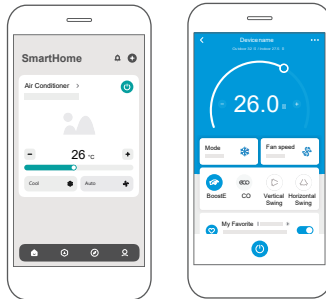

4. Compliance

Wireless module models:

EU-SK107, US-SK107:

FCC ID: 2ADQOMDNA21 IC:

12575A-MDNA21

EU-SK110, US-SK110:

FCC ID: 2ADQOMDNA23

IC: 12575A-MDNA23

This device complies with Part 15 of the FCC Rules and it contains license-exempt transmitter (s) / receiver (s) that comply with Innovation, Science and Economic Development Canada's licence-exempt RSS (s).

Operation is subject to the following two conditions:

1. This device may not cause harmful interference;
2. This device must accept any interference, including interference that may cause undesired operation of the device.

Only operate the device following the instructions supplied.

Changes or modifications to this unit not expressly approved by the party responsible for compliance could void the user's authority to operate the equipment.

This device complies with FCC radiation exposure limits set forth for an uncontrolled environment. To avoid the possibility of exceeding the FCC radio frequency exposure limits, human proximity to the antenna shall not be less than 8 in. (20 cm) during normal operation.

In Canada:

CAN ICES-3(B)/NMB-3(B)

Le présent appareil est conforme aux CNR Innovation, Sciences et Développement économique Canada applicables aux appareils radio exempts de licence.

L'exploitation est autorisée aux deux conditions suivantes:

(1) il ne doit pas produire de brouillage et (2) l'utilisateur du dispositif doit être prêt à accepter tout brouillage radioélectrique reçu, même si ce brouillage est susceptible de compromettre le fonctionnement du dispositif.

Cet émetteur ne doit pas être Co-placé ou ne fonctionnant en même temps qu'aucune autre antenne ou émetteur. Cet équipement devrait être installé et actionné avec une distance.

NOTE

This equipment has been tested and found to comply with the limits for a Class B digital device, pursuant to part 15 of the FCC Rules. These limits are designed to provide reasonable protection against harmful interference in a residential installation. This equipment generates, uses, and can radiate radio frequency energy and, if not installed and used in accordance with the instructions, may cause harmful interference to radio communications. However, there is no guarantee that interference will not occur in a particular installation. If this equipment does cause harmful interference to radio or television reception, which can be determined by turning the equipment off and on, the user is encouraged to try to correct the interference by one or more of the following measures:

--Reorient or relocate the receiving antenna.

--Increase the separation between the equipment and receiver.

--Connect the equipment into an outlet on a circuit different from that to which the receiver is connected.

--Consult the dealer or an experienced radio/TV technician for help.

The design and specifications are subject to change without prior notice for product improvement.

Consult with the sales agency or manufacturer for details.

United States



<https://www.mideacomfort.us/registration.html>

Canada



<https://www.mideacomfortna.ca/registration.html>

Comfort Extra Wired Remote Control IM & UM Rev. 3 12022025
©2025 Midea All Rights Reserved